



www.reeltech.co.kr

PRODUCT GUIDE 2019

自动升降系统



CCTV



LIGHTING FIXTURE



BANNER



PLUG SOCKET



SMOKE DETECTOR



CHANDELIER

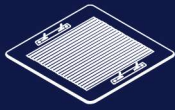

AIR CONDITIONER GRILL



Product range



■ 照明灯升降产品



■ 多触点升降器



■ 线型升降器



■ 火灾探测升降器





■ CCTV监控产品升降器



■ 遥控器 & 人体感应传感器 & 无线电板



■ 横幅&屏风升降器



■ 吸顶式灯筒升降器



■ 升降槽板

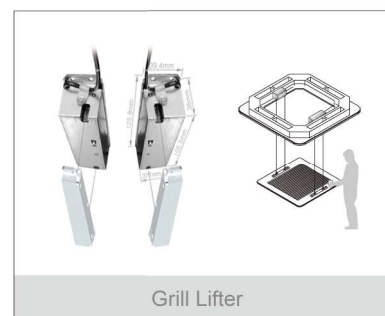

■ 同步升降器

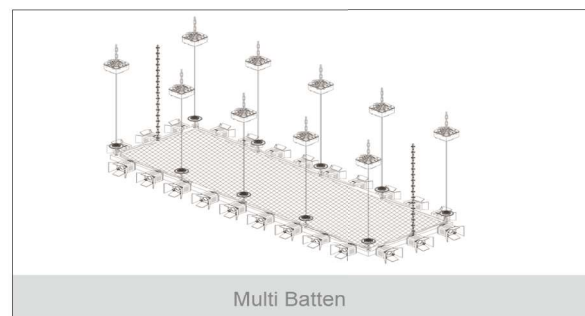

■ LED



■ 花盆等装饰物品升降器

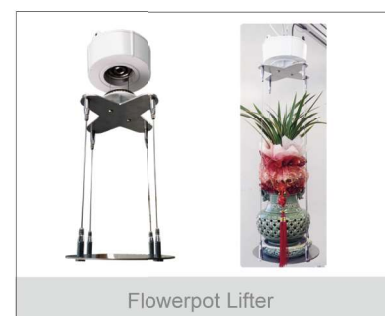



何为自动升降系统.....

该产品是一款安装在高顶棚上可升降照明、CCTV监控器、烟感火灾探测器、插座、宣传横幅等，使维修安全、方便的创新产品。



No danger!

无需在危险的高处进行操作，可预防维修中发生的危险事故。



No equipment!

该产品可升降到地表进行维修，无需另外租赁高昂的升降设备。



No electric shock!

该升降器下降操作时，处于断电状态，无触电危险。



Safe!

因在地表进行安全操作，可预防坠落事故，十分安全。



Save cost!

在维修时，无需停止操作，可防止因停止作业发生的损失，也可节省设备租赁费用。



Fast!

维修时可以缩短时间，必要时可以立即检查。

升降系统的安全装置



安全锁装置

对接时，内置承重量为1吨的坚固叫停装置，钢绳无承重，因此也无坠落危险。

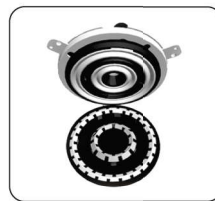

圆形触点

圆形触电因触点面积大，加上具备独立弹性、导电性极佳。



无载荷感应装置

该产品触地或遇到障碍物，而感应到无负荷时，便会自动停止操作。

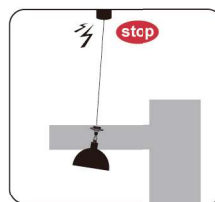

超负荷感应装置

当产品遇到障碍物，即可自动停止。



自动停止功能

用遥控器预先设定好停止高度，便可始终在相应位置自动停止。

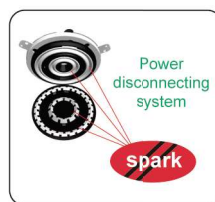

无电火花

即使在照明电源开启时进行下降操作，电源也会自行切断，因此是不会发生电火花的安全系统。



过热感应功能

由于连续操作，引起马达过热时，便会自动停止操作，待马达温度冷却后，再重新开始操作。

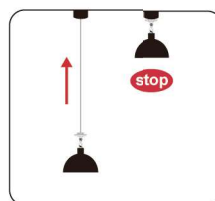

感应上升停止功能

升降器升到最高点后，自动停止上升。

控制装置

升降系统通过如下手动板与无线控制装置来控制。
 仅用1个遥控器就能控制1百万个升降器，迷你遥控器只能控制一个升降器，因此适合家庭使用。
 不过远红外迷你遥控器则可以控制多个升降器。

遥控器



传送方式	FM频率方式
频率	433.9200MHz
功率	10mW
传送距离	within 100m
控制数量	1,000,000 EA
电源	4.5V(AAA x 3)

- 独立控制模式
 - 照明ON/OFF
 - 控制升&降
 - 确认照明使用时间
 - 确认升降次数
 - 设定自动下降停止高度
- 集体控制模式
 - 照明ON/OFF
 - 控制升&降
- 全体控制模式
 - 照明ON/OFF

迷你遥控器



传送方式	远红外方式	传送方式	FM频率方式
频率	-	频率	433.9200MHz
功率	10mW	功率	10mW
传送距离	6~7m	传送距离	within 100m
控制数量	many	控制数量	1 EA
电源	3.0V(AAA x 2)		3.0V(AAA x 2)

无线板



传送方式	FM频率方式
频率	433.9200MHz
功率	10mW
传送距离	within 100m
控制数量	1,000,000 EA
电源	AC220V

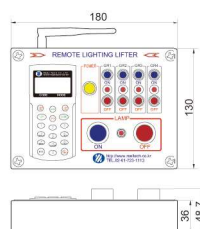

将无线板安装于墙面，与遥控器使用同一功能，因此无丢失风险。
 轻松、简便。

人体感应传感器



传送方式	FM频率方式
频率	433.9200MHz
功率	10mW
传送距离	within 100m
控制数量	1,000,000 EA
电源	AC220V

传感器感应人们的动态后，可自动ON/OFF照明。



面板

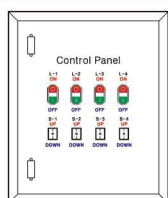

传送方式	传达有线信号
面板大小	500 x 600 x 180
印章颜色	MUNSELL No. 5Y 7/1
外罩厚度	1.5T
输入电源	AC 380V, 3 Phase
操作电源	AC220V

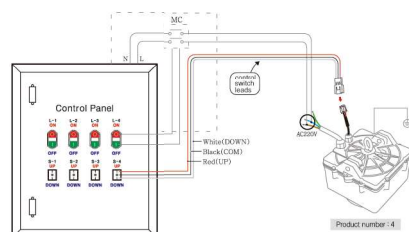

面板大小，视安装现场环境，会有所改变。



迷你型

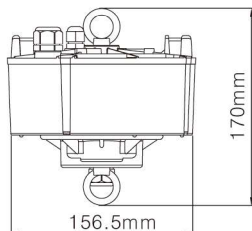
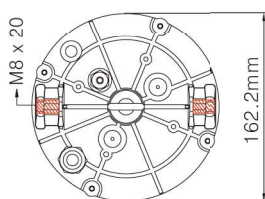

特点	型号	MSI-1	MSI-3	MSI-5	MDI-3	MDI-6	MDI-9
■ 小型产品 迷你型作为最小的产品, 适合在顶棚等空间狭小的地方使用, 适用于吸顶式聚光灯或LED等较轻的灯具	产品大小	162.2(W) x 170(H)			162.2(W) x 170(H)		
	产品重量	2.2kg	2.2kg	2.2kg	2.2kg	2.2kg	2.2kg
■ 安装地点 住宅、地铁站、工厂、体育馆、教会、物流中心、咖啡店等	可承载重量	~1kg	~3kg	~5kg	~3kg	~6kg	~9kg
	升降距离	15M			7M		
	钢丝数	1			2		
	钢丝绳尺寸	1.2mm			1.2mm		
	照明灯具额定电流	16A			16A		
	电机	DC Motor			DC Motor		

混凝土顶棚安装

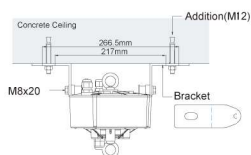

家用支架安装

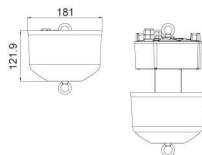

6英寸吸顶式聚光灯安装

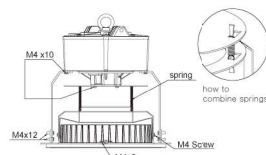

8英寸吸顶式聚光灯安装

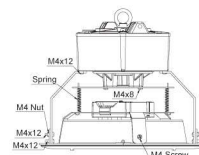

嵌入安装方法



嵌入安装方法



嵌入安装方法

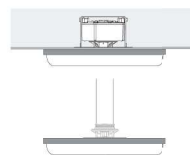

家庭用安装方法

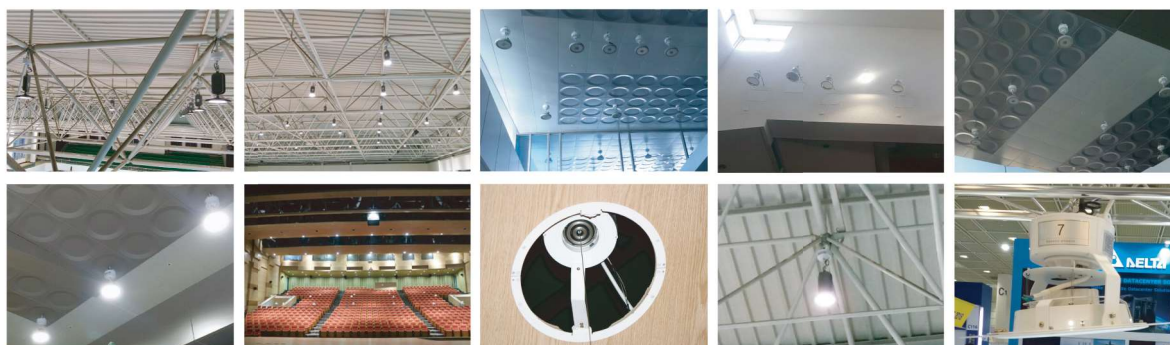

小巧型

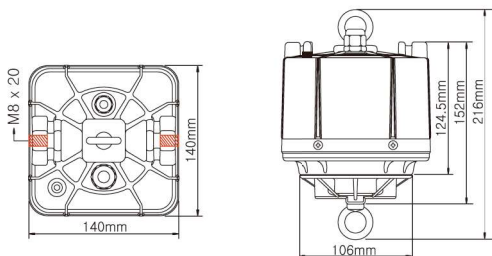

特点	型号	CSI-12	CDI-15
<ul style="list-style-type: none"> 最受欢迎的模型 设计的轻巧简便，适用于吸顶式聚光灯与LED等比较轻的灯具 	产品大小	140(W) x 140(D) x 216(H)	
	产品重量	3.1kg	3.13kg
<ul style="list-style-type: none"> 安装地点 体育馆、物流中心、工厂、地铁站、教会、游泳馆、机场、演出场等 	可承载重量	3~10kg	3~15kg
	升降距离	15M	10M
	钢丝数	1	2
	钢丝绳尺寸	1.4mm	1.2mm
	照明灯具额定电流	16A	16A
	电机	DC Motor	DC Motor

四角管道安装

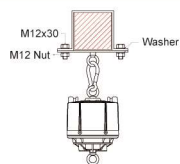

混凝土顶棚安装

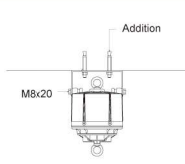

混凝土顶棚安装

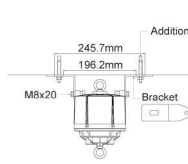

筑物安装构

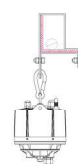

H投影仪安装

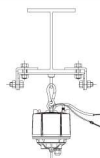

管道安装

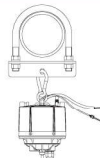

赛道安装

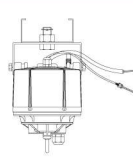

管道安装

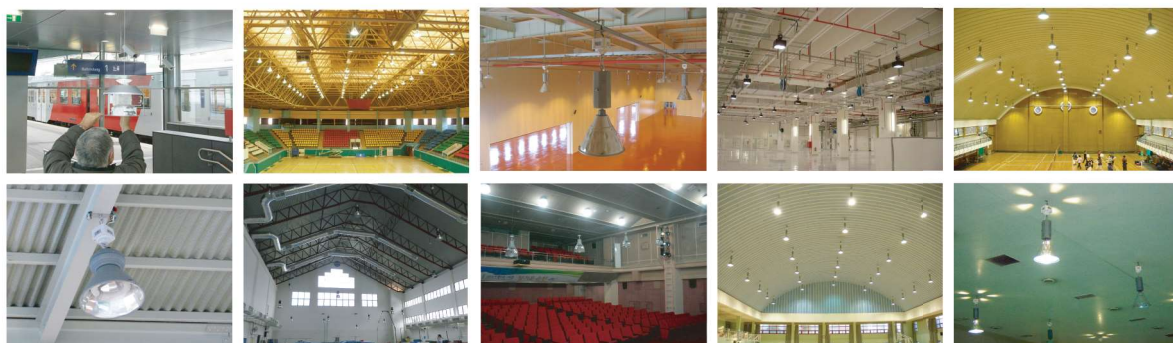
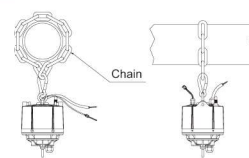



挂钩型

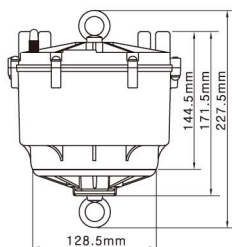
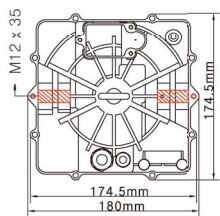

特点	型号	HSI-18	HDI-25
<ul style="list-style-type: none"> 最初开发的模型 	产品大小	175(W) x 175(D) x 228(H)	
	产品重量	6.53kg	6.62kg
<p>该产品为最初研发的产品，适用于LED 400W或吊顶灯具等重荷重的灯具。</p> <ul style="list-style-type: none"> 安装地点 <p>体育馆、工厂、教堂、物流中心、地铁站、游泳馆、机场等</p>	可承载重量	3~15kg	6~25kg
	升降距离	15M	10M
	钢丝数	1	2
	钢丝绳尺寸	2.0mm	1.6mm
	照明灯具额定电流	16A	16A
	电机	AC Motor	AC Motor

混凝土顶棚安装

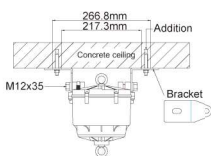

管道安装

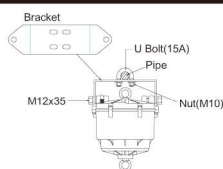

H投影仪(固定型)安装

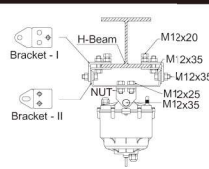

H投影仪(挂钩型)安装

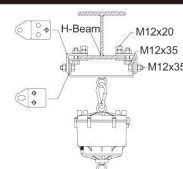

H投影仪(挂钩型)安装

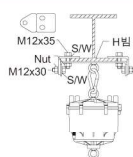

C型钢安装

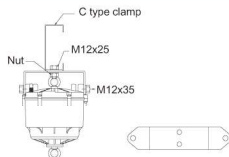

4角框安装

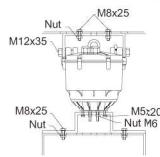

通风口下盖安装

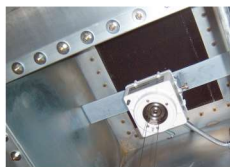
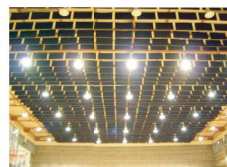
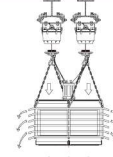

强力型

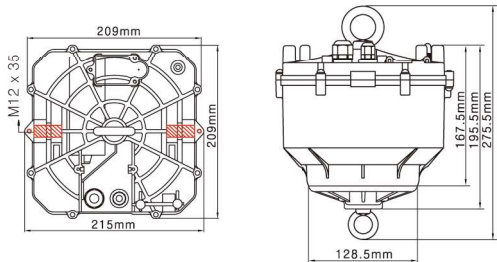

特点	型号	PSI-20	PDI-35	PSI-30	PDI-50
<ul style="list-style-type: none"> 适用于比较重的照明灯具的模型 强力型是适合水晶灯、吊灯等比较重的灯具的产品	产品大小	209(W) x 209(D) x 276(H)			
	产品重量	8.19kg	8.19kg	8.44kg	8.44kg
<ul style="list-style-type: none"> 安装地点 酒店、婚礼大厅、宴会厅、电影院、教会、教堂等	可承载重量	4~20kg	8~35kg	4~30kg	8~50kg
	升降距离	15M	10M	15M	10M
	钢丝数	1	2	1	2
	钢丝绳尺寸	2.4mm	2.0mm	2.4mm	2.0mm
	照明灯具额定电流	16A	16A	16A	16A
	电机	AC Motor		BLDC Motor	

C型钢安装

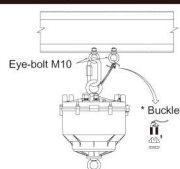

H投影仪安装

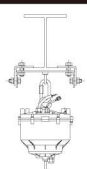

管道安装



管道安装

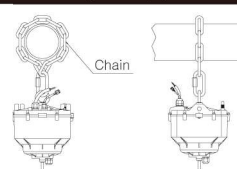

混凝土顶棚安装

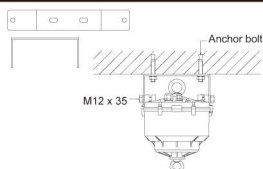

拱形板安装

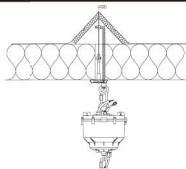

吊环螺栓安装



拱形板安装

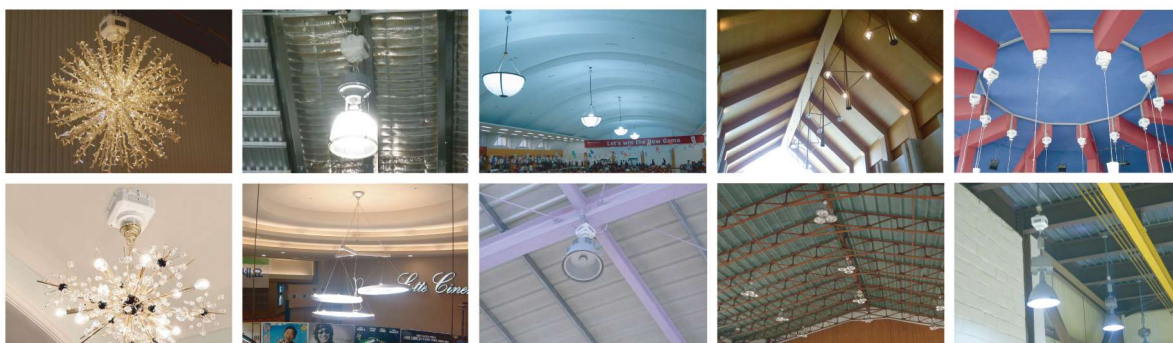
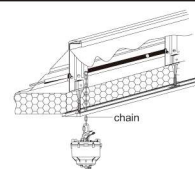



超强力型

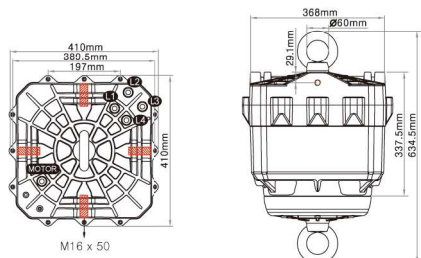

特点	型号	PFI-100	PFI-200	PFI-300	PFI-500
<ul style="list-style-type: none"> 100kg以上非常重的灯具用 该模型适用于100kg以上，非常重的吊顶灯具。 安装地点 宴会厅、婚礼大厅、酒店、教会、教堂、购物中心等 	产品大小	410(W) x 410(D) x 635(H)			
	产品重量	57.5kg	58kg	58kg	59kg
	可承载重量	50~100kg	60~200kg	100~300kg	100~500kg
	升降距离	30M	20M	20M	15M
	钢丝数	4	4	4	4
	钢丝绳尺寸	3.0mm	4.0mm	4.0mm	5.0mm
	照明灯具额定电流	32A	32A	32A	32A
	电机	BLDC Motor		BLDC Motor	

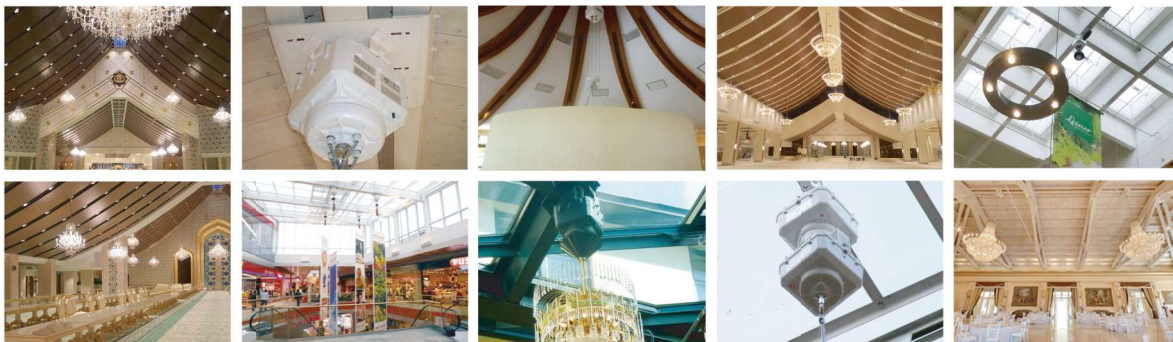
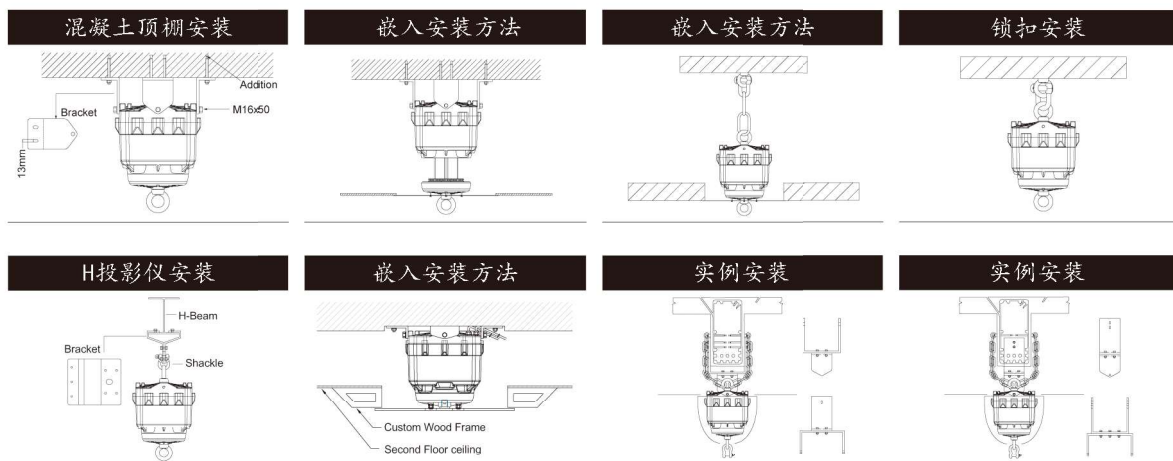

多触点升降器



<ul style="list-style-type: none"> 触点 <ul style="list-style-type: none"> 单线型：8触点 双线型：6个触点 应用 <ul style="list-style-type: none"> CCTV、音响、DALI系统、多角形照明等 										
型号	MSI-5M	MDI-9M	CSI-12M	CDI-15M	HSI-18M	HDI-25M	PSI-20M PSI-30M	PDI-35M PDI-50M		
产品大小	162(W) x 176.5(H)		140(W) x 140(D) x 221(H)		175(W) x 175(D) x 251(H)		209(W) x 209(D) x 298(H)			
产品重量	2.2kg	2.2kg	3.1kg	3.13kg	6.53kg	6.62kg	8.19/8.44kg	8.19/8.44kg		
可承载重量	1~5kg	2~9kg	3~10kg	3~15kg	3~15kg	6~25kg	4~20/30kg	8~35/50kg		
升降距离	15M	7M	15M	10M	15M	10M	15M	10M		
钢丝数	1	2	1	2	1	2	1	2		
钢丝绳尺寸	1.2mm	1.2mm	1.4mm	1.2mm	2.0mm	1.6mm	2.4mm	2.0mm		
照明灯具额定电流	16A	16A	16A	16A	16A	16A	16A	16A		
电机	DC Motor		DC Motor		AC Motor		AC/BLDC	AC/BLDC		

迷你型

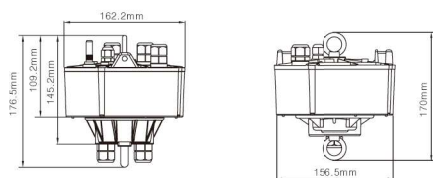

小巧型

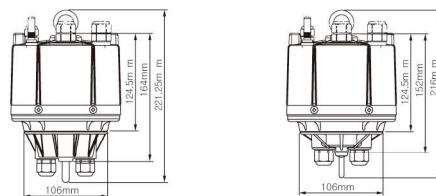

挂钩型

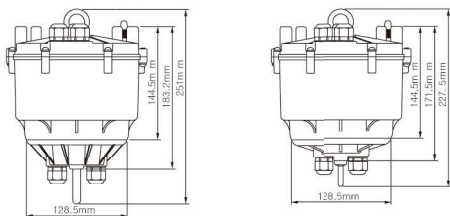

强力型

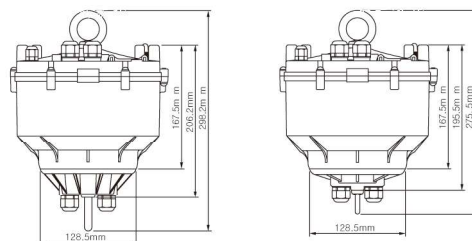

8触点



- ① SPARE
- ② SIGNAL 1
- ③ SIGNAL 2
- ④ SIGNAL 3
- ⑤ SIGNAL 4
- ⑥ EARTH(GREEN/YELLOW)
- ⑦ POWER(L) - BROWN COLOR
- ⑧ POWER(N) - BLUE COLOR

6个触点



- ① POWER(N) - BLUE COLOR
- ② POWER(L) - BROWN COLOR
- ③ SIGNAL 1
- ④ SIGNAL 2
- ⑤ SIGNAL 3
- ⑥ SIGNAL 4



线型升降器

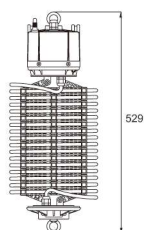
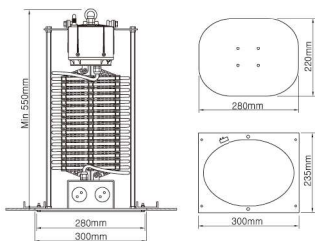

特点	型号	LSI-10C	LSI-10L
<ul style="list-style-type: none"> 操作中,电源保持开启状态的模型下降中, 仍然保持电源开启的产品 	产品大小	300(W) x 235(D) x 550(H)	140(W) x 140(D) x 529(H)
	产品重量	8.5kg	6.7kg
<ul style="list-style-type: none"> 安装地点 科 研 室、实 习 室、工 厂、 研 究 室、 陈 列 台、购 物 中 心 等 	可承载重量	-	3~7kg
	升降距离	2M	2M~
	钢丝数	1	1
	钢丝绳尺寸	1.2mm	1.4mm
	照明灯具额定电流	N/A	16A
	电机	DC Motor	DC Motor

应用

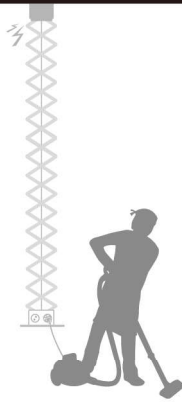

安装

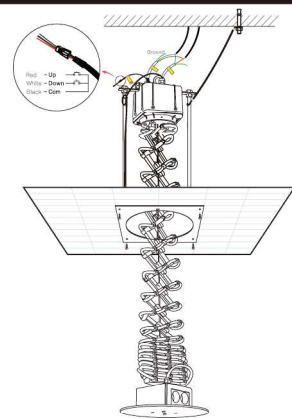

火灾感应升降器

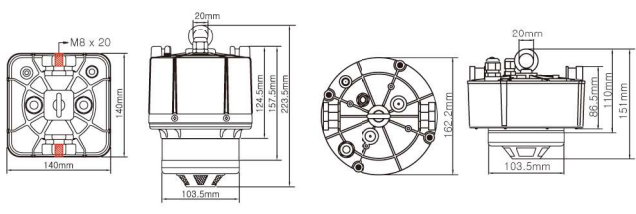

特点	型号	FSI-2	FSI-1
<ul style="list-style-type: none"> 火灾感应器用模型 定期检验火灾感应器的升降装置 	产品大小	140(W) x 140(D) x 187(H)	162.2(W) x 110(H)
	产品重量	3.1kg	2.2kg
<ul style="list-style-type: none"> 安装地点 体育馆、工厂、地铁站、机场、公共建筑、教会等 	可承载重量	1~2kg	1kg
	升降距离	15M	15M
	钢丝数	1	1
	钢丝绳尺寸	1.2mm	1.2mm
	照明灯具额定电流	-	-
	电机	DC Motor	DC Motor

安装

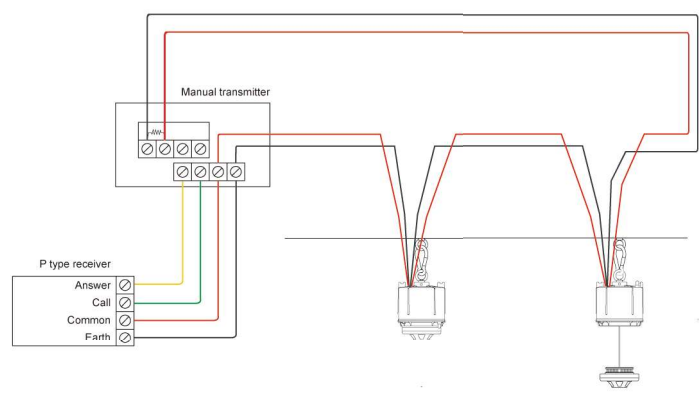
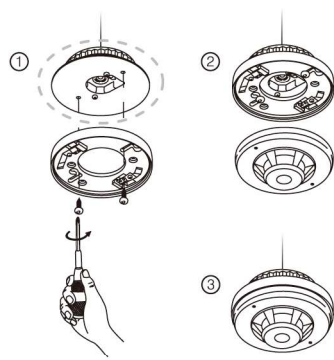



CCTV监控升降器

特点	型号	MSI-5C	CSI-7C	HSI-15C
<ul style="list-style-type: none"> CCTV用升降装置 该模型是为了清洁与维修CCTV镜头的升降装置。 安装地点 公园、学校、公共建筑、机场、地铁站、购物中心、小巷等 	产品大小	185.4(W) x 208.8(H)	248(W) x 292(H)	
	产品重量	3.7kg	6.2kg	10kg
	可承载重量	1~5kg	3~7kg	4~15kg
	升降距离	15M	15M	15M
	钢丝数	1	1	1
	钢丝绳尺寸	1.2mm	1.4mm	2.0mm
	照明灯具额定电流	16A	16A	16A
	电机	DC Motor	DC Motor	AC Motor

安装

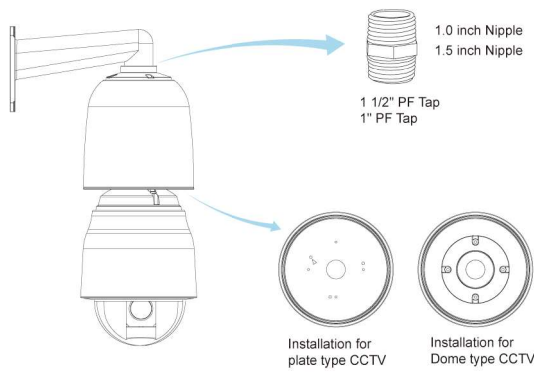

为什么要使用CCTV升降器?

• 清洁CCTV镜头

使用升降装置定期清洁CCTV镜头，可确保无时无刻鲜明的影像画质。



• 进行安全地CCTV 维修

因不用爬高，可安全地在地表对CCTV进行维修工作。



横幅升降器&屏风升降器

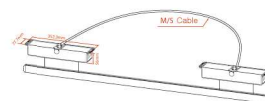
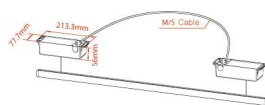
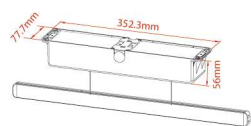

型号	BDL-3	BSL-3	BFL-3
产品大小	352.3(W) x 77.7(D) x 56(H)	213.3(W) x 77.7(D) x 56(H)	352.3(W) x 77.7(D) x 56(H)
产品重量	3.1kg	3.1kg	2.2kg
可承载重量	less than 2kg	less than 2kg	less than 4kg
升降距离	4M	4M	4M
钢丝数	2	2	4
钢丝绳尺寸	0.8mm	0.8mm	0.8mm
照明灯具额定电流	-	-	-
电机	AC Motor	AC Motor	AC Motor

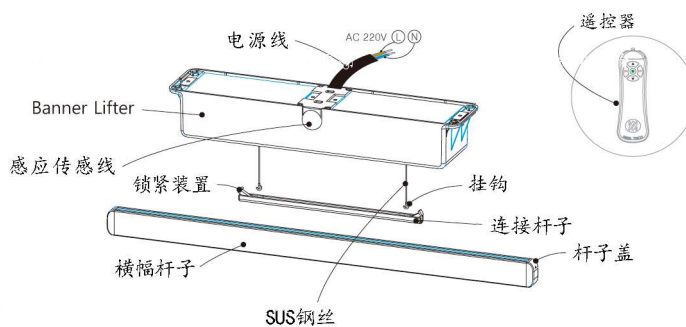

功能

1 设定自动停止下降功能

- 轻按“停止”10次, 在“滴”声之后, 杆子便会上下移动。

2 可水平调节杆子

- 轻按“停止”10次, 在“滴”声之后, 杆子便会上下移动还是以“Up”键和“Down”键调节杆子的平衡。
- 按“停止”1次。

3 可设定下降时间(仅限横幅升降器)

- 轻按“停止”10次, 在“滴”声之后, 杆子便会上下移动。
- 每按一次“On”键, 将增加1秒操作时间。



同步升降器



同步升降器将2台升降器同期化，可同时操控2台升降器。

同步升降器适用于位于一般体育馆、舞台、会议中心等顶棚较高处安装的宣传横幅、屏幕、舞台照明等。



迷你型



小巧型



挂钩型



强力型



超强力型

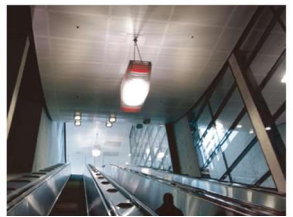



天花板空调过滤网升降器

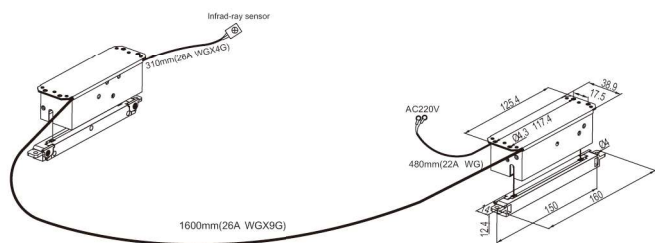

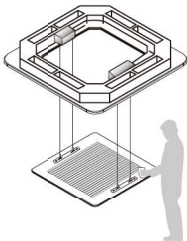
特点	型号	GFL-3
<p>天花板空调过滤网升降器是升降顶棚型系统空调槽板的产品。顶棚型系统空调的槽板（过滤网）落灰，便会引起空调功效低、易故障现象，因此，每隔2~3个月应清洁一次。升降槽板有助于轻松、安全的清洁槽板。</p> 	产品大小	126(W) x 40(D) x 36(H)
	产品重量	0.5kg
	可承载重量	2kg
	升降距离	4M
	钢丝数	2
	钢丝绳尺寸	0.8mm
	照明灯具额定电流	0.6A
	电机	DC Motor

升降槽板适用于学校教室、宴会厅、饭店、酒店、公寓、办公室、公共场所等各种场所。

1. 节能降耗 (30%以上)
2. 预防过敏、呼吸道感染等疾病
3. 确保安全性 (在地表清洁槽板)
4. 净化空气效果
5. 预防空调故障
6. 遥控器及开关均可操作
7. 提升空间利用率
8. 安装简便



可适用于已安装的三星、LG、东芝及一般空调系统

主要功能

- 维持左右侧平衡的功能

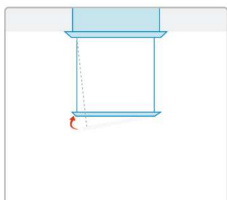

升降过程各种功能出现左右侧不平衡现象时，可立即交换另一端位置数据，以确保在保持一定水平的情况下，进行升降操作。

- 自动停止下降的功能

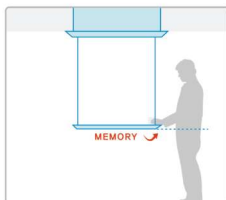

下降时，预先设定好利于清扫的高度，即可始终在该位置自动停止。

- 无负荷感应功能

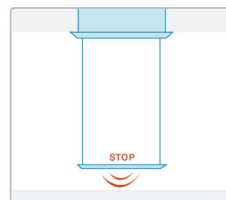

下降时，遇到障碍物或触底后，处于无负荷状态时，即进入到自动停止模式。



LED 照明

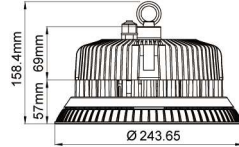
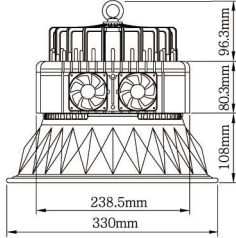

特点	型号	RT-LED200	RT-LEDN150	RT-LEDN200	
<ul style="list-style-type: none"> ■ 高效能认证产品 节能降耗 环保产品 节省维修费用 便利性 ■ 安装地点 体育馆、工厂、仓库、地铁站、公共建筑等 	产品大小	330(W) x 285(H)	244(W) x 158(H)		
	产品重量	5.7kg	3.1kg		
	消费电力	200W	150W	200W	
	功率	0.99	0.95	0.96	
	总光通量	18551lm	18339lm	24636lm	
	钢丝绳尺寸	5728K	5931K	5892K	
	显色指数	79	80.1	80	
	电压 / 频率	220V / 60Hz		220V / 60Hz	

安装于墙面

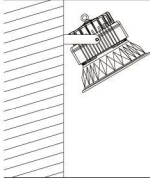

吊环螺栓安装



嵌入安装方法

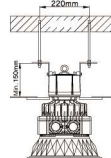

拱形板安装

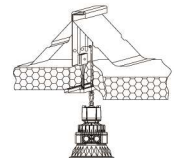

管道安装

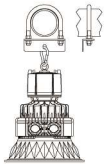

H投影仪安装

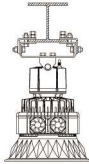

H投影仪安装



H投影仪安装

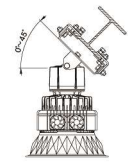

升降器和LED套装模型

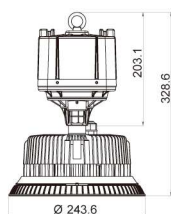
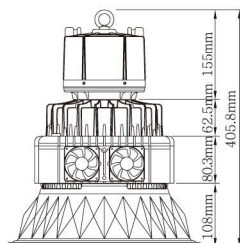

特点	型号	CSI-7L	CSI-LN200
■ 套装模型 以升降装置与LED套装模型，达到节能降耗、确保安全效果的经济型产品。	产品大小	330(W) x 406(H)	244(W) x 329(H)
	产品重量	8.8kg	6.2kg
■ 安装地点 体育馆、工厂、仓库、发电所、机场、地铁站等	可承载重量	3~7kg	3~7kg
	升降距离	15M	15M
	钢丝数	1	1
	钢丝绳尺寸	1.4mm	1.4mm
	照明灯具额定电流	16A	16A
	电机	DC Motor	DC Motor

LED与升降装置连接方法

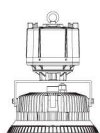

混凝土顶棚安装



安装以后可调节角度



安装以后可调节角度



为什么要使用升降装置？落灰时，LED的使用寿命将大幅缩短。

- ◆ 保证40000hr / 8年(仅限套装模型)
 - 确认LED累计使用时间的功能
- ◆ 降低70~80%能耗
 - 通过人体感应传感器感知人的动态，从而自动开启或关闭LED。
- ◆ 回收投资经费所需时间：1.6年
- ◆ 防眩目功能(粘贴防眩目薄膜)
- ◆ 预防坠落事故、触电事故等安全事故

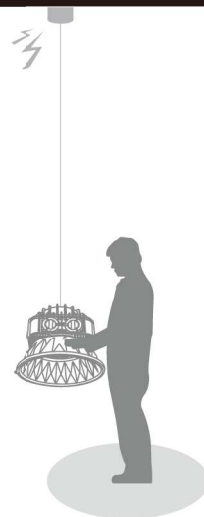

Reference

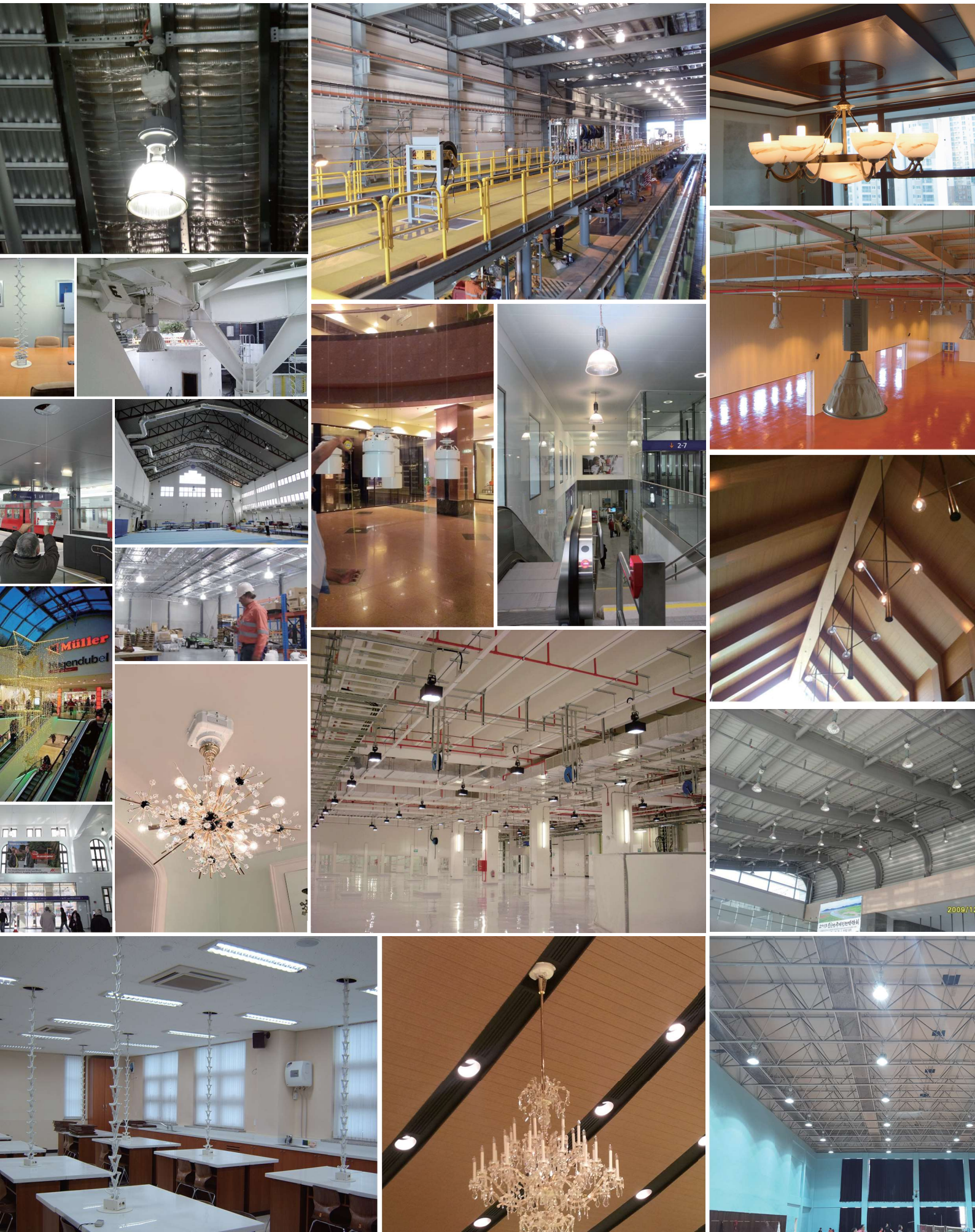

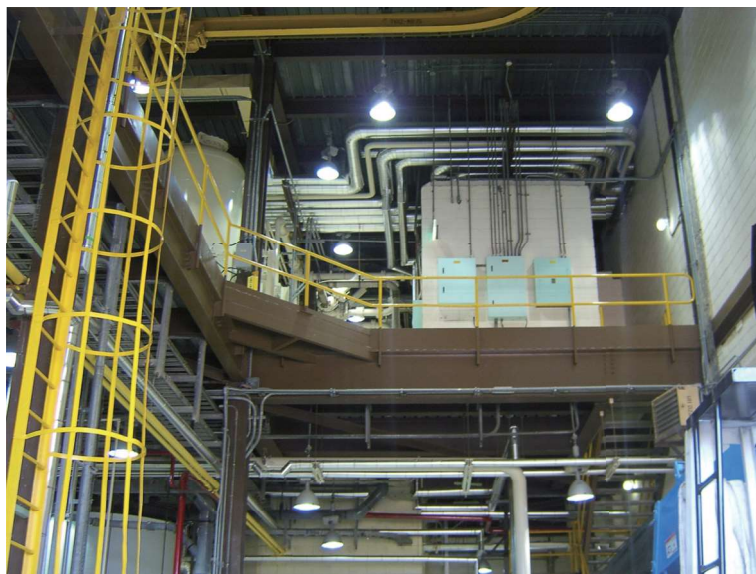
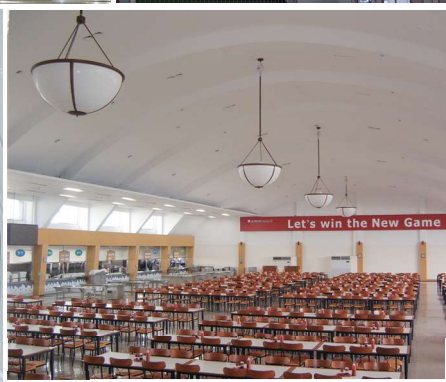
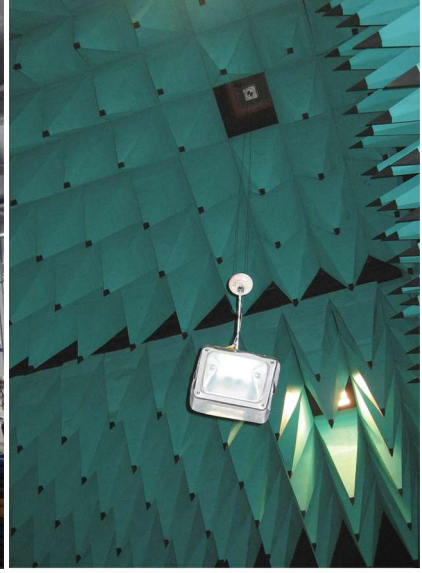

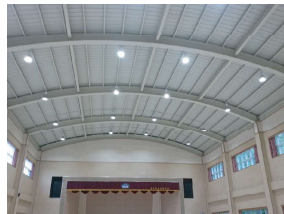
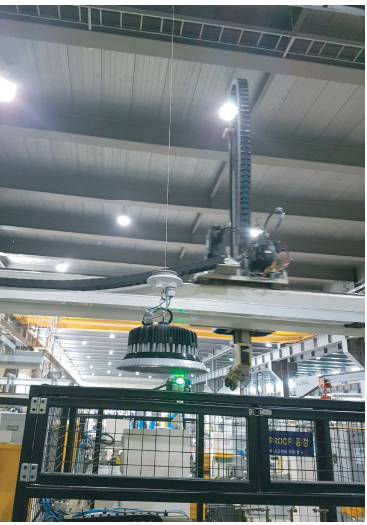
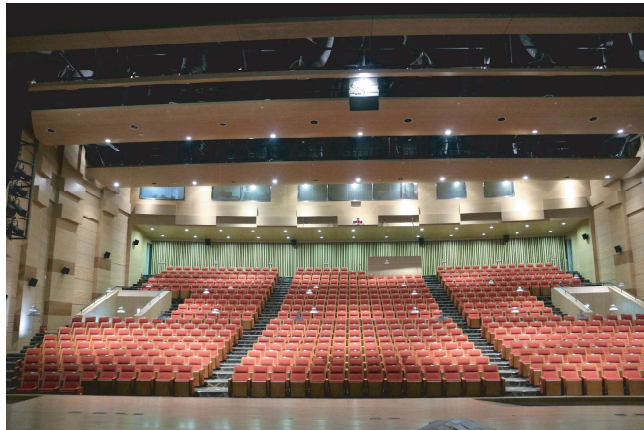
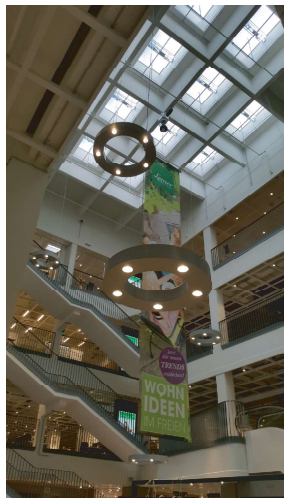

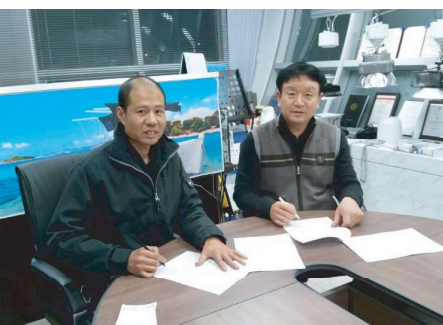
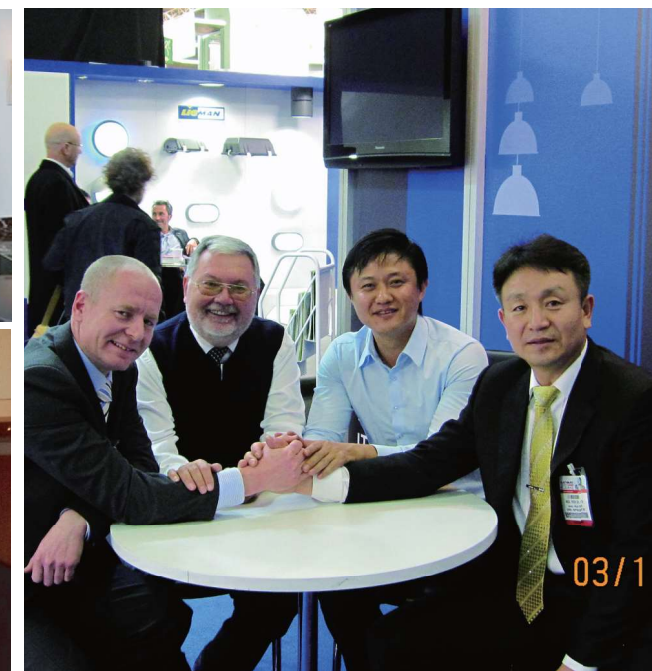
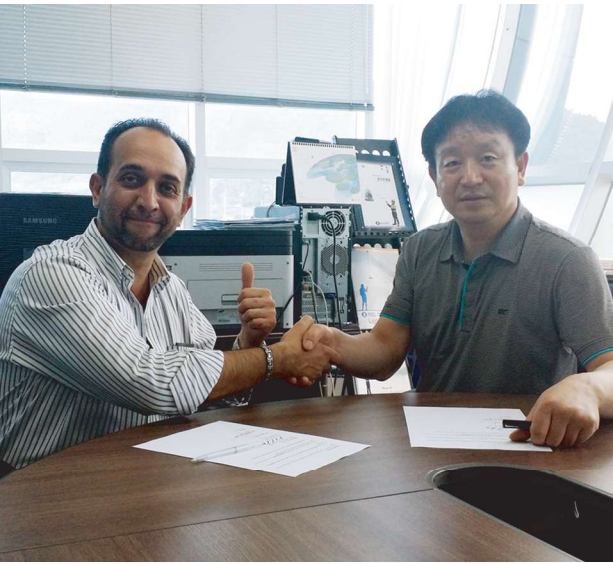



RUSSIA

Platan LLC

TEL : +8(495) 252-07-77
<http://www.platan.ru>
 email : volkov@platan.ru

UNITED KINGDOM

REEL TECH UK LTD.

TEL : +44(0) 1604 643522
 FAX : +44(0) 1604 697028
<http://www.reeltechuk.com>
 email : enquiries@reeltechuk.com

HUNGARY

REEL TECH HandelsgmbH

TEL : +43(0) 1 960 80 88
 FAX : +43(0) 1 960 80 88 - 80
<http://www.reeltech.eu>

ITALY

Santenini S.r.l.

TEL : +39 0331 924846
 FAX : +39 0331 920606
<http://www.santemimi.it>
 email : daniele.serventi@santenini.it

SLOVAKIA

AMI spol.s.r.o.

TEL : +421 35 6923900
 FAX : +421 35 6923960
 email : ami@ami.sk

CZECH

BASE Diming s.r.o.

TEL : +420 602 344 162
 email : j.lamac@basediming.com

AUSTRIA

REEL TECH HandelsgmbH

TEL : +43(0) 1 960 80 88
 FAX : +43(0) 1 960 80 88 - 80
<http://www.reeltech.eu>
 email : office@reeltech.eu

GERMANY

REEL TECH Vertriebs GmbH

TEL : +49(0) 6109 / 5016151
 FAX : +49(0) 6109 / 5016150
<http://www.reeltech.de>
 email : office@reeltech.de

SWITZERLAND

Demelectric AG

TEL : +41(43) 455 4400
 FAX : +41(43) 455 4411
<http://www.demelectric.ch>
 email : info@demelectric.ch

POLAND

MBB,s.c.

TEL : +48(0) 22 331 75 70
 FAX : +48(0) 22 840 15 54
<http://www.mbb.pl>
 email : mbb@mbb.pl



HEAD OFFICE TEL : +82 61 723 1113 FAX : +82 61 723 4440 e-mail : reel-tech@hanmail.net / reeltech@naver.com

SINGAPORE

LIGHTCRAFT LTD PTE

TEL : +65 6744 2441
 FAX : +65 6744 1416
<http://www.lightcraft.com.sg>
 email : enquiry@lightcraft.com.sg

AUSTRALIA

LIGHT MOUNTING SYSTEMS

TEL : +61 02 4932 9000
 FAX : +61 02 4932 9009
<http://www.lightmountingsystems.com.au>
 email : sales@lmsau.com

KUWAIT

YOUSEF AL-AHMAD INT GROUP

TEL : +965 24821302
 FAX : +965 24847725
<http://www.alahmedgroup.com>
 email : info@alahmedgroup.com

BAHRAIN

Genprise Co. W.L.L.

TEL : +973 17311442
 FAX : +973 17311019/17910761
<http://www.genpriseco.com>
 email : mitesh@genpriseco.com

MEXICO

AG Lighting SA de CV

TEL : +(52) (55) 6845-6002
<http://www.aglighting.mx>
 email : contacto@aglighting.mx

COLOMBIA

ZONA DE ENFOQUE NETWORK S.A.S

TEL : +57 314 892 53 17
<http://www.reeltechcolombia.co/>
 email : gerencia@reeltechcolombia.co

IRAN

BHE CO.

TEL : +98 713 648 0010
 FAX : +98 713 648 0011
<http://www.inenop.com>
 email : s.Afsar@bhe-co.com

MALAYSIA

M LUX SDN BHD

TEL : +603 7781 8954
<http://www.mlux.com.my>
 email : sales@mlux.com

FRANCE

MINOEUROPE SARL

TEL : +33 6 22 70 43 45
 email : haemaru.ryu@minoeurope.com

HONGKONG

Lightcraft Limited

TEL : +852 2866 6965
<http://www.lightcraftintl.com>
 email : info@lightcraft.asia

