

自动升降系统

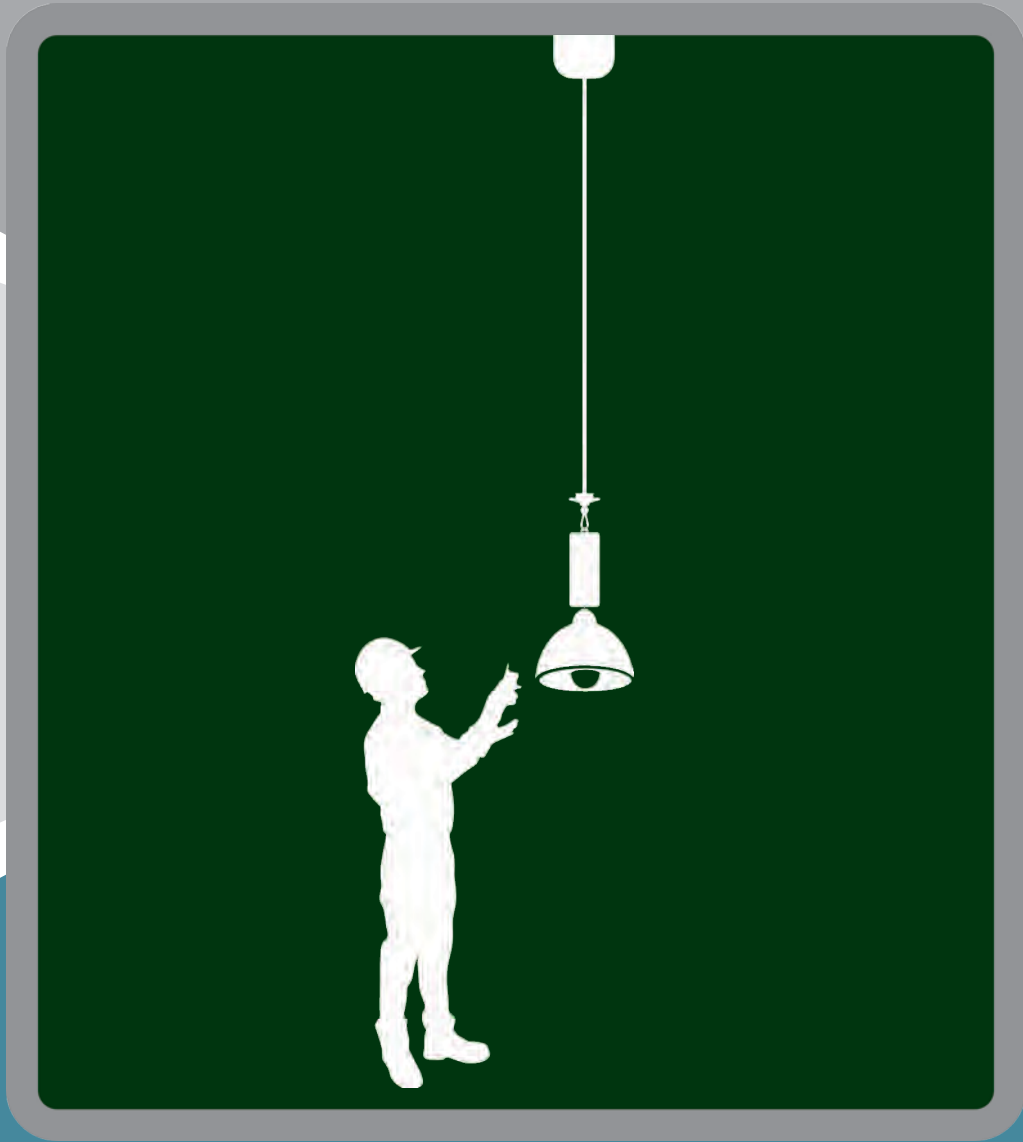











PRODUCT GUIDE 2023











对于高空LED照明，插座，CCTV，火灾探测器，通风设备和宣传横幅来说，自动升降系统是必需品
适用于体育馆，地铁站，工厂，物流仓库，科学室，实验室，游泳馆，教会，教堂
结婚礼堂，宴会厅，酒店，机场，发电站，展厅等任何场所

自动升降系统











基本型号

									
MSI-3	MDI-5	CSI-12	CDI-15	HSI-18	HDI-25	PSI-20	PSI-30	PDI-35	PDI-50

插座升降器

									
PFI-100	PFI-200	PFI-300	PFI-500	即将推出	LSI-7	LSI-10	LSI-PS	LSI-3	LDI-3

多触点升降器

									
MSI-1M	MDI-5M	CSI-12M	CDI-15M	HSI-18M	HDI-25M	PSI-20M	PDI-35M	PSI-30M	PDI-50M



CCTV升降产品

					
MSI-1CH	MDI-5CH	CSI-7CH	CDI-12CH	HSI-12CH	HDI-25CH

同步升降器

		
适用全部型号	通风设备升降器	多触点同步升降器





横幅&屏风&防疫隔离板

		
BDL-2	BDL-2D	BDL-4D

火灾探测器 筒灯 升降槽

		
FSI-1	筒灯升降器	升降槽

控制装置

				
RT-RCU	RT-IR	RT-WS	RT-WLS	R-WP

LED&太阳能路灯







LED泛光灯

							
RT-LEDN150	RT-LEDN200	MSI-LN150	MSI-LN200	CSI-LN150	CSI-LN200	CSI-7D150	CSI-7D200

室外用可升降LED

CSI-LH200

太阳能路灯

	独立型		独立型		独立型		发电型		发电型		发电型
RT-SLL		RT-SLCL		RT-SLC2L		RT-SLLK		RT-SLCLK		RT-SLC2LK	







产品认证&专利



					
					
					
					







招标采购登记物品目录

● 照明升降器

* 可根据使用高度定制

品名						
型号	MSI-3	CSI-7	HSI-12	PSI-20	PSI-30	LSI-7
规格	1~3kg, 15m	2~7kg, 15m	3~12kg, 15m	4~20kg, 15m	4~30kg, 15m	2m
产品识别编号	23646412	21223398	20641868	21223413	23660408	21223412

品名						
型号	FSI-1	MSI-1M	CSI-5M	HSI-10M	PSI-20M	PSI-30M
规格	15m	1kg, 15m	2~5kg, 15m	3~10kg, 15m	4~20kg, 15m	4~30kg, 15m
产品识别编号	23089282	23643638	23649301	23649302	23646428	23646430







品名						
型号	CSI-7B	HSI-12B	LSI-3	LDI-3	RT-LEDN150	RT-LEDN200
规格	2~7kg, 15m	3~12kg, 15m	2M	2M	150W	200W
产品识别编号	23646425	23646427	24764395	24764396	23308302	23308303





品名						
型号	MSI-LN150	CSI-LN150	CSI-LN200	CSI-7D150	CSI-7D200	RT-WLS
规格	1~3kg, 15m	2~7kg, 15m	2~7kg, 15m	2~7kg, 15m	2~7kg, 15m	70*92*41
产品识别编号	23643639	23308299	23308300	23643641	23643642	23646434

品名						
型号	RT-RCU	R-HB	R-P	R-A	R-WP	R-WPC
规格	50*130*20	H-beam 规格	Pipe 规格	210*124*4T	180*130*36	300*400*150(120)
产品识别编号	23646435	21223488	21223491	23643643	21223490	21223489

招标采购登记物品目录







● 照明升降器

品名						
型号	R-WC	R-LPANEL4	R-LPANEL5	R-LPANEL6	R-LPANEL7	R-LPANEL8
规格	300*400*150(120)	500*600*180(220)	500*600*180(220)	600*700*180(220)	600*700*180(220)	600*700*180(220)
产品识别编号	24338967	24338971	24338972	24338973	24338975	24338976

品名						
型号	R-CPANEL56	R-CPANEL78	R-CPANEL910	R-PANEL4	R-PANEL5	R-PANEL6
规格	400*500*150	400*500*150	400*500*150	500*600*180(220)	500*600*180(220)	600*700*180(220)
产品识别编号	24338977	24338978	24338979	21701740	21701741	21701742

品名					
型号	R-PANEL7	R-PANEL8	C-PANEL56	C-PANEL78	C-PANEL910
规格	600*800*180(220)	600*800*180(220)	400*500*150	400*500*150	400*500*150
产品识别编号	21701743	21701744	22423419	22423418	22423417

● 太阳能路灯

品名						
型号	RT-SLL	RT-SLCL	RT-SLC2L	RT-SLLK	RT-SLCLK	RT-SLC2LK
规格	50W, 3.5M	50W*2, 3.5M	50W*3, 3.5M	50W, 3.5M	50W*2, 3.5M	50W*3, 3.5M
产品识别编号	24060117	24060112	24060113	24060114	24060115	24060116



Move It! It's Possible!

照明升降器

● 可在地面安全地对灯具进行维护维修



No danger!

无需在危险的高处进行作业，可预防维修中危险事故的发生



No equipment!

因在地面就可以对灯具进行维修，则无需租用高昂的升降设备



No electric shock!

该升降器下降操作时，会自动断电，因此无触电危险



Safe!

因在地面进行作业，可预防坠落事故，所以十分安全



Save cost!

在维修时，无需停产，可防止因停产造成的损失，并且可以节省租用设备的费用



Fast!

使用升降器维修时，可缩短维修时间，必要时可立即进行检查。



工厂

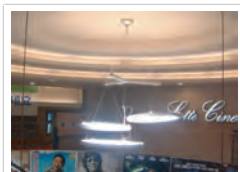

电影院



室内体育馆



地铁站

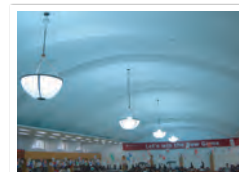

公司食堂



公寓



寺庙

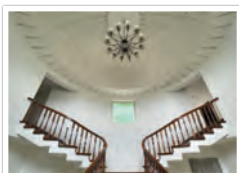

别墅

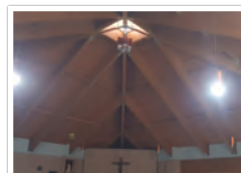







教堂











污水处理厂

● 照明升降器

* 可根据使用高度定制

产品						
型号	MSI-3	MDI-5	CSI-12	CDI-15	HSI-18	HDI-25
产品规格(mm)	162.2(W)*170(H)		140(W)*140(D)*216(H)		175(W)*175(D)*228(H)	
产品重量(kg)	2.2kg	2.2kg	3.1kg	3.13kg	6.6kg	6.69kg
可承载重量(kg)	1~3kg	2~5kg	3~10kg	3~15kg	3~15kg	6~25kg
可升降高度(M)	15M	7M	15M	7M	15M	7M
钢丝绳数量	1	2	1	2	1	2
钢丝绳直径	1.2mm	1.2mm	1.4mm	1.2mm	2.0mm	1.6mm
照明额定电流	16A	16A	16A	16A	16A	16A
电机	DC Motor	DC Motor	DC Motor	DC Motor	DC Motor	DC Motor

产品								
型号	PSI-20	PDI-35	PSI-30	PDI-50	PFI-100	PFI-200	PFI-300	PFI-500
产品规格(mm)	209(W)*209(D)*276(H)		209(W)*209(D)*276(H)		410(W)*410(D)*635(H)			
产品重量(kg)	7.63kg	7.63kg	8.44kg	8.44kg	57.5kg	58kg	58kg	59kg
可承载重量(kg)	4~20kg	8~35kg	4~30kg	8~50kg	50~100kg	60~200kg	100~300kg	100~500kg
可升降高度(M)	15M	7M	15M	7M	30M	20M	20M	15M
钢丝绳数量	1	2	1	2	4	4	4	4
钢丝绳直径	2.4mm	2.0mm	2.4mm	2.0mm	3.0mm	4.0mm	4.0mm	5.0mm
照明额定电流	16A	16A	16A	16A	32A	32A	32A	32A
电机	DC Motor	DC Motor	BLDC Motor	BLDC Motor	BLDC Motor	BLDC Motor	BLDC Motor	BLDC Motor



火车站

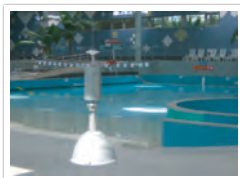

游泳馆

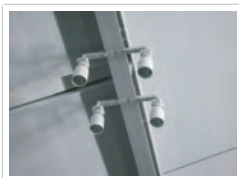

机场

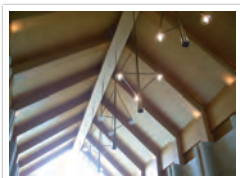

公寓

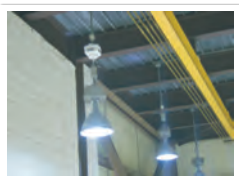

发电站

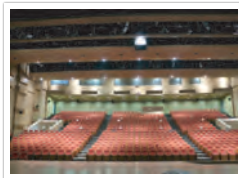

政府综合大楼礼堂



会议厅



大型购物中心



物流中心

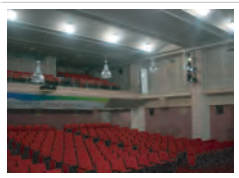

文化艺术中心



多功能礼堂

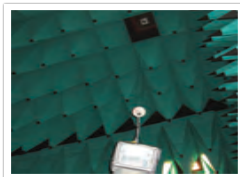

屏蔽室



青少年训练中心



门球场



军事基地



Move It! It's Possible!

插座升降器

● 把很长的电线嵌入安装在顶棚里，需用时从空而降！



✓ 在学校

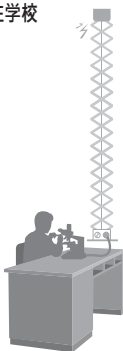

✓ 在工厂

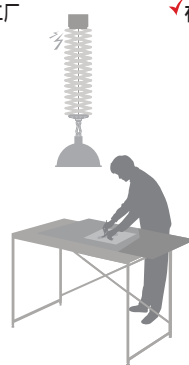

✓ 在家里

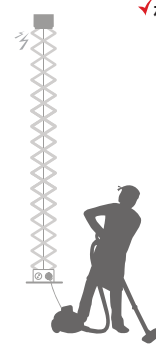

✓ 在办公室

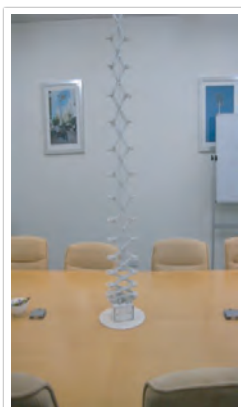
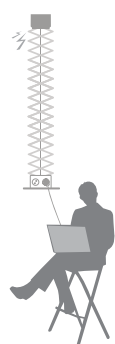

办公室



食品柜台



学校化学室



烹饪实习室



室外



科学实验室



科学实验室



实习室

● 插座升降器

* 可根据使用高度定制

产品					
型号	LSI-7	LSI-10	LSI-PS	LSI-3	LDI-3
产品规格(mm)	300(W)*235(D)*570(H)	140(W)*140(D)*529(H)	440(W)*220(D)*296(H)	228(W) x 228(D) x 301(H)	
产品重量(kg)	8.5kg	6.7kg	4.7kg	6.1kg	6.83kg
可承载重量(kg)	-	3~7kg	10kg~	-	-
可升降高度(M)	2M	2M~	2M~	2M/最大7M(可定制)	2M/最大3M(可定制)
钢丝绳数量	1	1	1	1	2
钢丝绳直径	1.4mm	1.4mm	1.4mm	-	-
额定电流	16A	16A	16A	16A	16A
电机	DC Motor	DC Motor	-	DC Motor	DC Motor

升降插座的多种应用

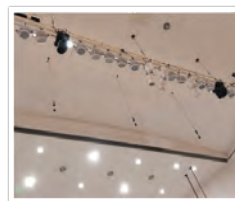
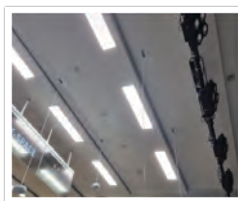
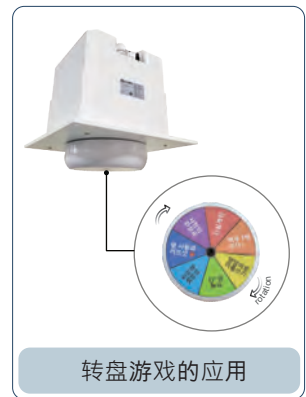



Move It! It's Possible!

多触点升降器

● 在需要固定方向性的方形照明或CCTV、音响、DALI等产品中使用

8个触点(单丝)



- ① — 信号 1
- ② — 信号 2
- ③ — 信号 3
- ④ — 信号 4
- ⑤ — 地线 (绿/黄)
- ⑥ — 电源 L - 灰色)
- ⑦ — 电源 N - 蓝色)
- ⑧ — 空闲触点

6个触点(双丝)



- ① — 电源 (N - 蓝色)
- ② — 电源 (L - 灰色)
- ③ — 信号 1
- ④ — 信号 2
- ⑤ — 信号 3
- ⑥ — 信号 4

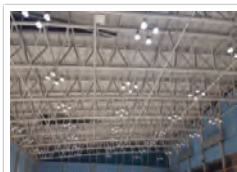

室内羽毛球场



游泳馆



网球场



多功能体育馆

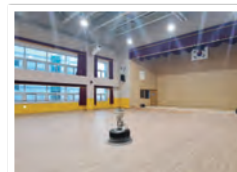

学校礼堂

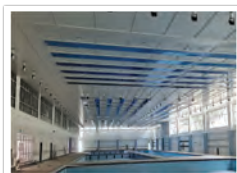

游泳馆



多功能体育馆



多功能体育馆







学校礼堂



多功能体育馆

● 多触点升降器

* 可根据使用高度定制

产品				
型号	MSI-1M	MDI-5M	CSI-12M	CDI-15M
产品规格(mm)	162(W) x 176.5(H)	162(W) x 176.5(H)	140(W) x 140(D) x 221(H)	140(W) x 140(D) x 221(H)
产品重量(kg)	2.2kg	2.2kg	3.1kg	3.13kg
可承载重量(kg)	1kg	2~5kg	3~10kg	3~15kg
可升降高度(M)	15M	7M	15M	7M
钢丝绳数量	1	2	1	2
钢丝绳直径	1.2mm	1.2mm	1.4mm	1.2mm
照明额定电流	16A	16A	16A	16A
电机	DC Motor	DC Motor	DC Motor	DC Motor

产品						
型号	HSI-18M	HDI-25M	PSI-20M	PSI-30M	PDI-35M	PDI-50M
产品规格(mm)	175(W) x 175(D) x 251(H)	175(W) x 175(D) x 251(H)	209(W) x 209(D) x 298(H)	209(W) x 209(D) x 298(H)	209(W) x 209(D) x 298(H)	209(W) x 209(D) x 298(H)
产品重量(kg)	6.6kg	6.69kg	7.63kg	8.44kg	7.63kg	8.44kg
可承载重量(kg)	3~15kg	6~25kg	4~20kg	4~30kg	8~35kg	8~50kg
可升降高度(M)	15M	7M	15M	15M	7M	7M
钢丝绳数量	1	2	1	1	2	2
钢丝绳直径	2.0mm	1.6mm	2.4mm	2.4mm	2.0mm	2.0mm
照明额定电流	16A	16A	16A	16A	16A	16A
电机	DC Motor	DC Motor	DC Motor	BLDC Motor	DC Motor	BLDC Motor

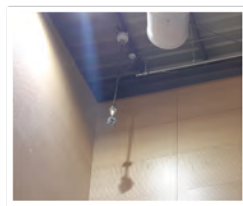
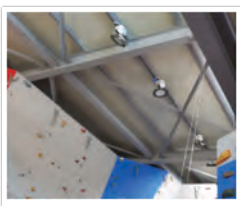



Move It! It's Possible!

火灾检测升降器

● 火灾检测升降器

* 可根据使用高度定制

产品		
型号	FSI-1	MSI-1M
产品规格(mm)	162(W) x 151(H)	162(W) x 176.5(H)
产品重量(kg)	2.2kg	2.2kg
可承载重量(kg)	1kg	1kg
可升降高度(M)	15M	15M
钢丝绳数量	1	1
钢丝绳直径	1.2mm	1.2mm
电机	DC Motor	DC Motor

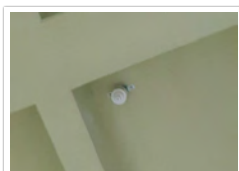

变电站

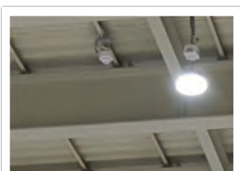

学校礼堂



学校礼堂



变电站

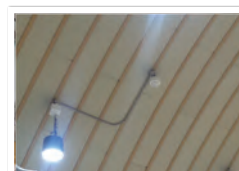

学校礼堂



● 宣传横幅，太极旗，空气循环设备，大型宣传物，舞台照明等应用

同步升降器 两台升降器同时升下降

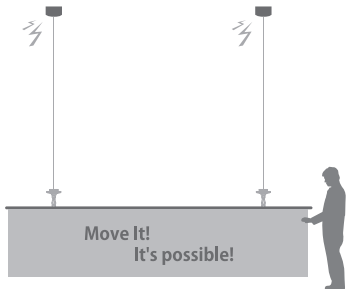

多触点同步升降器 3台以上升降器同时升下降

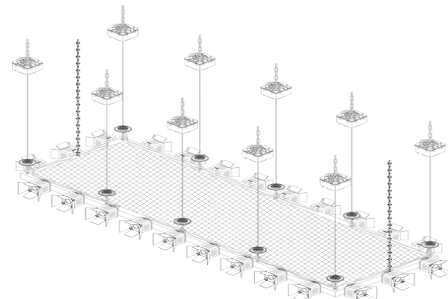

小巧型



挂钩型



强力型



超强力型

▲ 所有型号都适用

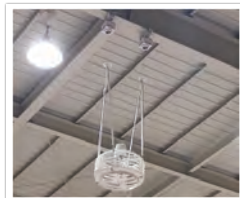
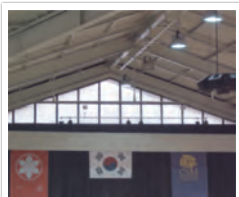



Move It! It's Possible!

CCTV升降器

为什么需要使用CCTV升降器？

清洁CCTV镜头

随时确保录像画质清晰

使用CCTV升降器定期清洁CCTV镜头，可以始终确保录像画质清晰。



镜头清洁前

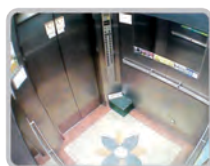

镜头清洁后

安全维护维修CCTV

预防工伤

无需爬高在地面就可以对CCTV进行清洁和维护，因此可预防坠落事故的发生



高空作业：危险

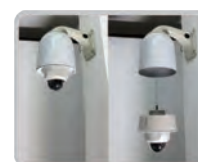



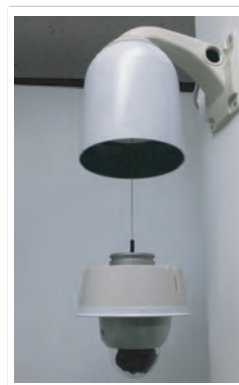



地面作业：安全



● CCTV升降器

* 可根据使用高度定制

产品				
型号	MSI-1CH	MDI-5CH	CSI-7CH	CDI-12CH
产品规格(mm)	185.4(W) x 208.8(H)	185.4(W) x 208.8(H)	248(W) x 292(H)	248(W) x 292(H)
产品重量(kg)	3.7kg	3.7kg	6.2kg	6.2kg
可承载重量(kg)	1kg	2~5kg	2~7kg	3~12kg
可升降高度(M)	15M	7M	15M	7M
钢丝绳数量	1	2	1	2
钢丝绳直径	1.2mm	1.2mm	1.4mm	1.2mm
个触点	8	6	8	6
电机	DC Motor	DC Motor	DC Motor	DC Motor

产品		
型号	HSI-12CH	HDI-25CH
产品规格(mm)	248(W) x 292(H)	248(W) x 292(H)
产品重量(kg)	10kg	10kg
可承载重量(kg)	3~12kg	6~25kg
可升降高度(M)	15M	7M
钢丝绳数量	1	2
钢丝绳直径	2.0mm	1.6mm
个触点	8	6
电机	DC Motor	DC Motor

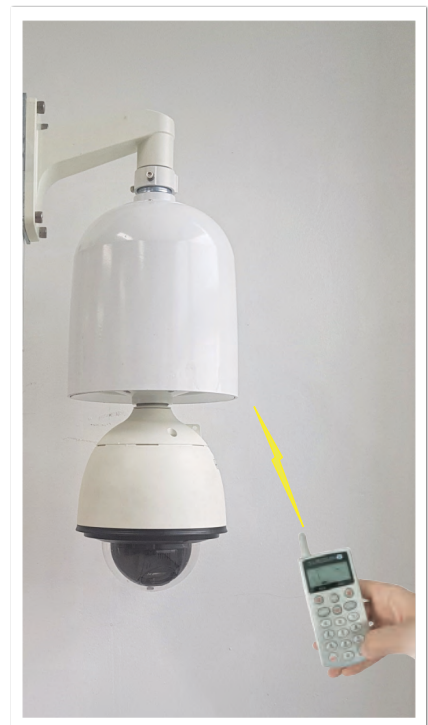
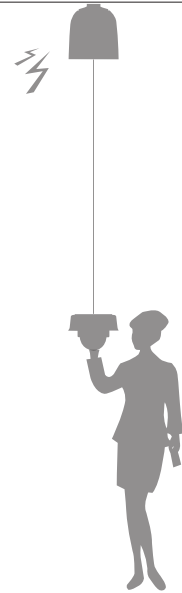



Move It! It's Possible!



横幅&屏风&防疫隔离板

宣传 & 防飞沫 & 保护隐私

餐厅、咖啡馆、公司办公室、会议室、宴会厅、展览会、大会议厅等。



● 横幅&屏风&防疫隔离板

产品			
型号	BDL-2	BDL-2D	BDL-4D
产品规格(mm)	352.3(W) x 77.7(D) x 56(H)	213.3(W) x 77.7(D) x 56(H) * 2EA	352.3(W) x 77.7(D) x 56(H) * 2EA
产品重量(kg)	3.1kg	3.1kg	6.2kg
可承载重量(kg)	~2kg	~2kg	~2kg
可升降高度(M)	4M	4M	4M
钢丝绳数量	2	2	4
钢丝绳直径	0.8mm	0.8mm	0.8mm
额定电流	0.04A	0.04A	0.04A
电机	AC Motor	AC Motor	AC Motor

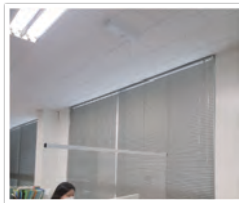
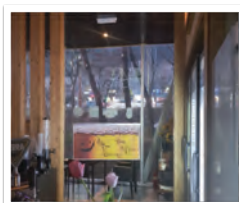



升降槽 GRILL LIFTER

Move It! It's Possible!

● 用于清洁中央空调滤网的升降产品

如果中央空调滤网堆积很多灰尘，空调效率就会下降，可能还会发生故障，因此需要定期清洁过滤网使用升降槽清洁维护中央空调滤网更安全更便利

产品	
型号	GFL-3
产品规格(mm)	126(W) x 40(D) x 36(H)
产品重量(kg)	0.5kg
可承载重量(kg)	2kg
可升降高度(M)	4M
钢丝绳数量	2
钢丝绳直径	0.8mm
额定电流	0.6A
电机	DC Motor

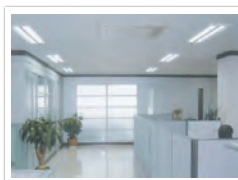
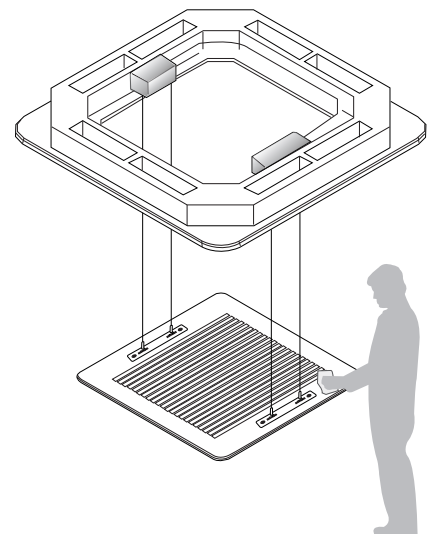



Move It! It's Possible!

LED & 升降LED

优势



绿色环保产品



高效认证



KC认证



KS认证



节省维护费用



节能



便利性

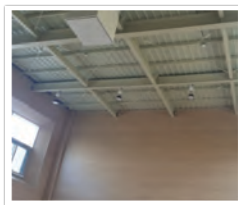
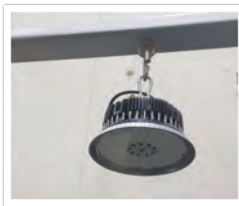

LED

* 可根据使用高度定制

产品			
型号	RT-LEDN150	RT-LEDN200	CSI-LH200
产品规格(mm)	244(W) x 158(H)	244(W) x 158(H)	244(W) x 370(H)
产品重量(kg)	3.1kg	3.1kg	9.3kg
产品功率	150W	200W	200W
功率因数	0.95	0.96	0.96
初始光通量	18778lm	24893lm	24893lm
色温 CCT	5650K	5656K	5656K
显色指数CRI	77	77	77
输入电压	220V/60Hz	220V/60Hz	220V/60Hz

升降LED

▼ 保修8年 (40,000小时以内)

产品						
型号	MSI-LN150	MSI-LN200	CSI-LN150	CSI-LN200	CSI-7D150	CSI-7D200
产品规格(mm)	244(W) x 285(H)	244(W) x 285(H)	244(W) x 329(H)	244(W) x 329(H)	244(W) x 344(H)	244(W) x 344(H)
产品重量(kg)	5.3kg	5.3kg	6.2kg	6.2kg	6.2kg	6.2kg
可承载重量(kg)	1~3kg	1~3kg	2~7kg	2~7kg	2~7kg	2~7kg
可升降高度(M)	15M	15M	15M	15M	15M	15M
钢丝绳数量	1	1	1	1	1	1
钢丝绳直径	1.2mm	1.2mm	1.4mm	1.4mm <td 1.4mm	1.4mm	
电机	DC Motor	DC Motor	DC Motor	DC Motor	DC Motor	DC Motor
触点	2	2	2	2	8	8

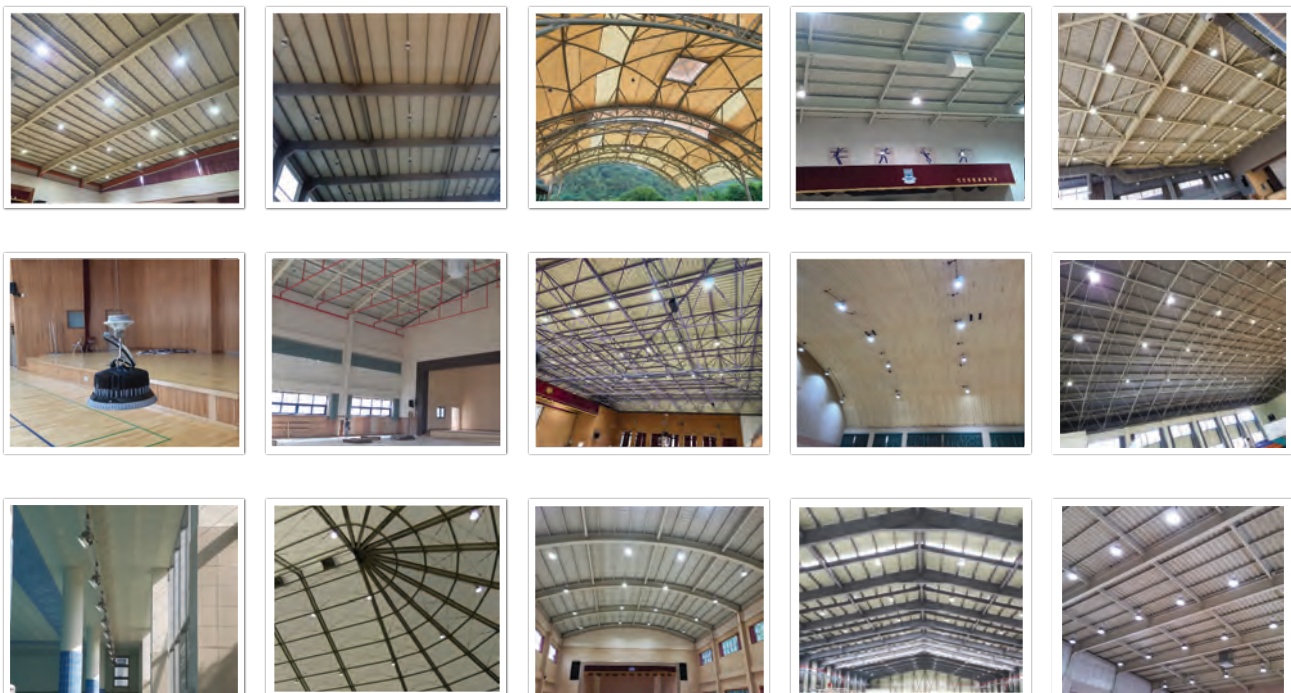



Move It! It's Possible!

太阳能升降安防灯杆

● 太阳能升降监控安防灯杆

- ✓ 可预防犯罪的设备
- ✓ 不需要施工供电，可以自主发电的优势
- ✓ 1天的用电量300W = 1小时的发电量 OK!

防范农田农产品盗窃及蓄意破坏的犯罪行为

安装在村口，农田，水塘等场所，可预防盗窃的犯罪行为

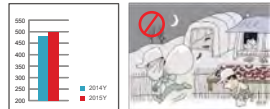

[全国农产品盗窃损失统计]

预防城市犯罪

安装在城市容易发生犯罪的地区（公园，偏僻窄道）可预防犯罪行为的发生。



[高阳市，安装后犯罪发生统计]

预防学校暴力

安装在学校内及周边地区（卫生间及道路周边），可预防学校暴力

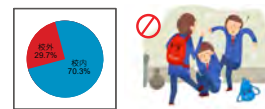

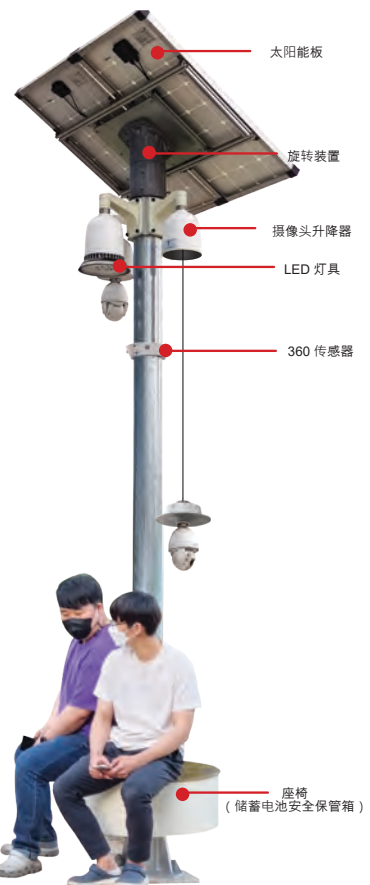

[校园暴力设计数据]





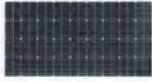

● 认证及专利



● 太阳能升降安防灯杆

构成				
名称	追踪装置	太阳能板	升降 CCTV	LED
规格	260 x 360 x 180mm(内径140mm) 14.5kg	1306 x 660 x 40mm 240W以上	15m 升下降 CCTV(SD卡) 无线监视功能 (WiFi)	50W 效率 : 141.5lm/W 显色性 : 77.5
特征	- 无电线触点连接方式 (触点寿命 20年保障) - 360度 旋转 - GPS+程序控制方式	- CE, RoHS 认证产品 - 高效单晶电池 - 高效转换率	- 完成风洞试验 (30ms以上) - 定期清洁镜片 , 确保录像画质清晰 - 维护安全便利	- 符合广播通讯设备合格基准 - 符合公共采购的最低绿色标准 - Dimming 功能

构成				
名称	360 传感器	蓄电池保管箱	蓄电池 (太阳能专用)	灯杆
规格	感知距离5~7m	Φ670 x 276mm, 铁板	SB1000 12V-100AH 250次循环 充电/放电 免维护密封电池	3.5m, 6.0T pipe Φ139.8 x 4.85
特征	- 通过感知移动物体控制LED	- 休息椅子的应用 - 封闭不外漏, 有防盗效果 - 覆盖面采用耐热材料	- 轻松检查充电状态 (Magic Eye 指示灯) - 防止外火流入 : 密封盖子 - 为防止短路使用保护隔板	热浸镀

● 适用场所





● 安装案例



● 空气循环风扇升降器

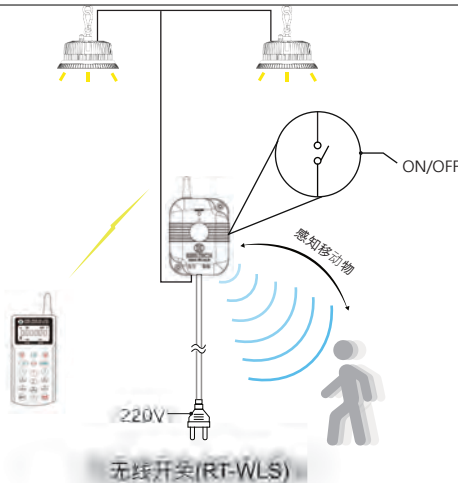

● 无线传感器&无线开关

产品		
型号	RT-WS	RT-WLS
产品规格(mm)	57.3(W)x38.2(D)X78.2(H)	70(W)x41(D)X92(H)
感知距离	5~7mm	5~7mm
使用温度	-20℃~+60℃	-20℃~+60℃
控制数量	最多100万台	最多100万台
特征	<ul style="list-style-type: none"> - 接收遥控信号用升降器控制照明开关 - 无线传感器通过感知移动物体时，用升降器来控制照明开关 - 感知移动物体时 ON，一定时间后 OFF(可设置1~99分钟) 	<ul style="list-style-type: none"> - 接受遥控信号或者感知移动物体时，用无线开关来控制照明的开关
工作原理	 <p>无线传感器(RT-WS)</p>	 <p>无线开关(RT-WLS)</p>

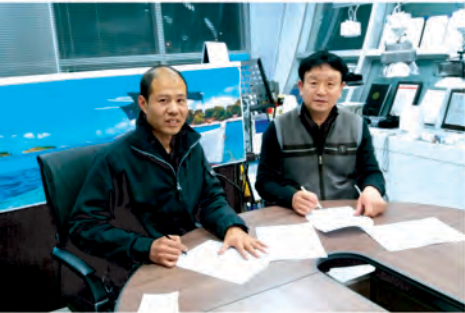
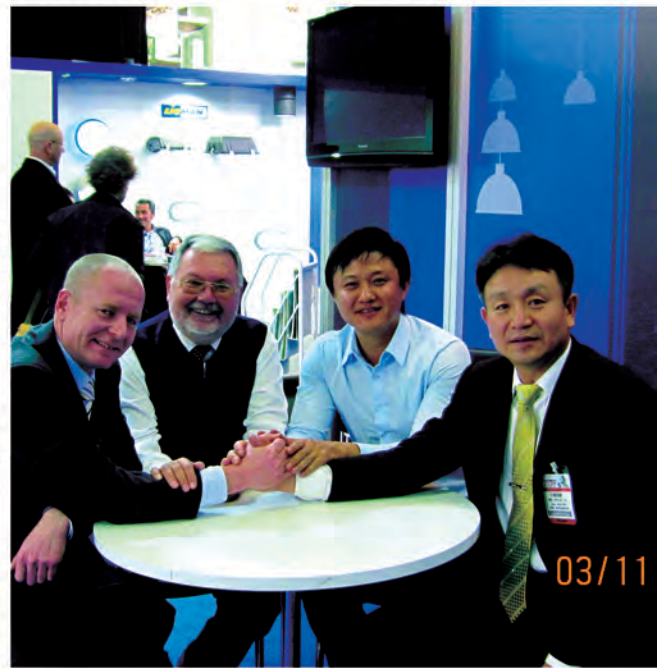
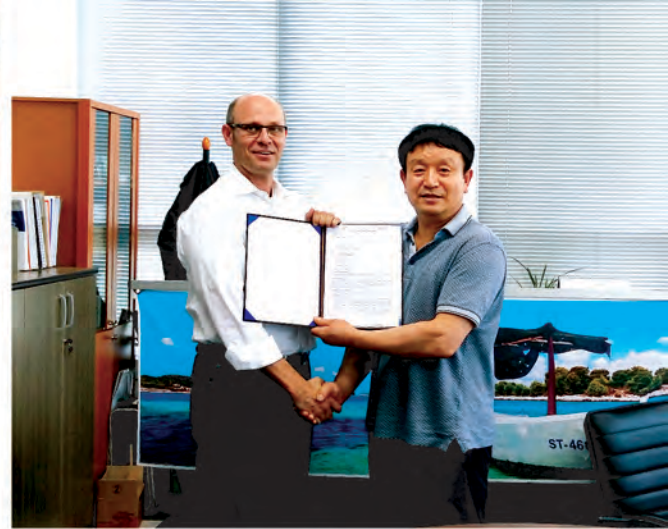
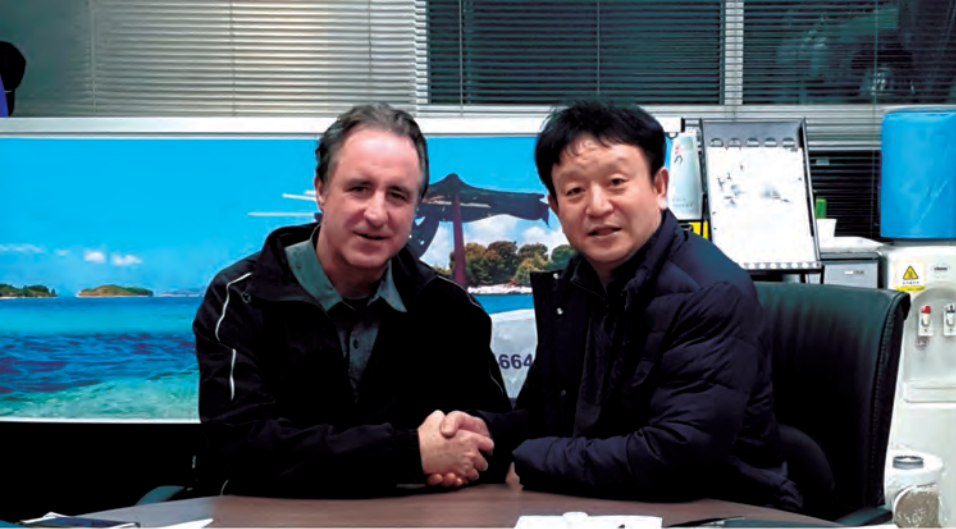



◆ 总公司

(株)REELTECH TEL : 061) 723-1113 FAX: 061) 723-4440 E-mail : reel-tech@hanmail.net http://www.reeltech.co.kr

◆ 国内代理店

地区	公司名称	电话	传真	网址	邮箱
首尔, 仁川	Mirae enerotec	032-812-4023	032-812-4024	www.reeltech.co.kr	sbj00@hanmail.net
京畿道	Seongwon	010-9632-3578		www.reeltech.co.kr	swt9876@hanmail.net
江原道, 庆北, 蔚山, 釜山, 庆南	Hanbit enerotech	052-991-7640~1	052-991-7642	www.reeltech.co.kr	hb7640@daum.net
忠北, 忠南, 世忠, 大田	RGB tech	070-8880-9183	050-4060-9183	www.reeltech.co.kr	ljm99@daum.net
全罗北道	Esselenc	063-224-4694	050-4461-4694	www.reeltech.co.kr	it0153@nate.com
光州, 全罗南道	KSTech	061-725-9964	061-724-9964	www.reeltech.co.kr	kstech3885@hanmail.net
济州岛	E2G	064-748-8446	064-748-8445	www.reeltech.co.kr	lenado@e2z.co.kr

◆ 海外代理

地区	公司名称	电话	传真	网址	邮箱
俄罗斯	PLATAN LLC	7(495)97-000-99		www.platan.ru	info@platan.ru
英国	REELTECH UK LTD.	+44(0)1604 643522	+44(0)1604 697028	www.reeltechuk.com	enquiries@reeltechuk.com
匈牙利	REEL TECH HandelsgmbH	+43(0)1 960 80 88	+43(0)1 960 80 88 - 80	www.reeltech.eu	
意大利	Santenini S.r.l	+39 0331 924846	+39 0331 920606	www.santenini.it	daniele.serventi@santenini.it
斯洛伐克	AMI spol.s.r.o	+421 35 6923900	+421 35 6923960		ami@ami.sk
捷克	BASE Diming s.r.o	+420 602 344 162			j.lamac@basediming.com
奥地利	REEL TECH HandelsgmbH	+43(0)1 960 80 88	+43(0)1 960 80 88 - 80	www.reeltech.eu	office@reeltech.eu
德国	REEL TECH Vertriebs GmbH	+49(0) 6109 / 5016151	+49(0) 6109 / 5016150	www.reeltech.de	office@reeltech.de
瑞士	Demelectric AG	+41(43) 455 4400	+41(43) 455 4411	www.demelectric.ch	info@demelectric.ch
波兰	MBB.s.c.	+48(0) 22 331 75 70	+48(0) 22 840 15 54	www.mbb.pl	mbb@mbb.pl
新加坡	LIGHTCRAFT PTE LTD	+65 6744 2441	+65 6744 1416	www.lightcraft.com.sg	enquiry@lightcraft.com.sg
科威特	YOUSEF AL-AHMAD INT GROUP	+965 24821302	+965 24847725	www.alahmedgroup.com	info@alahmedgroup.com
巴林	Genprise Co. W.L.L.	+973 17311442	+973 17311019/17910761	www.genpriseco.com	info@genpriseco.com
法国	MINOEUROPE SARL	+33 6 22 70 43 45			Haemaru.ryu@minoeeurope.com
墨西哥	AG Lighting SA de CV	+(52) (55) 6845-6002		www.aglighting.mx	contacto@aglighting.mx
哥伦比亚	ZONA DE ENFOQUE NETWORK S.A.S	+57 314 892 53 17		www.reeltechcolombia.co	gerencia@reeltechcolombia.co
伊朗	BHE CO.	+98 713 648 0010	+98 713 648 0011	www.inenop.com	s.Afsar@bhe-co.com
中国	SHENZHEN PHIAN S	+86 755 8621 8116		www.nuclearscm.com	1309582350@qq.com
中国	TIANJIN CHUANGFA TECHNOLOGY	+86 22 2368 9010			13920555675@163.com
中国	Txzj(WuHan) Technology	+86 138-7123-9075			2024225975@qq.com
香港	Lightcraft Limited	+852 2866 6965		www.lightcraftintl.com	info@lightcraft.asia