

Safety Lifting System

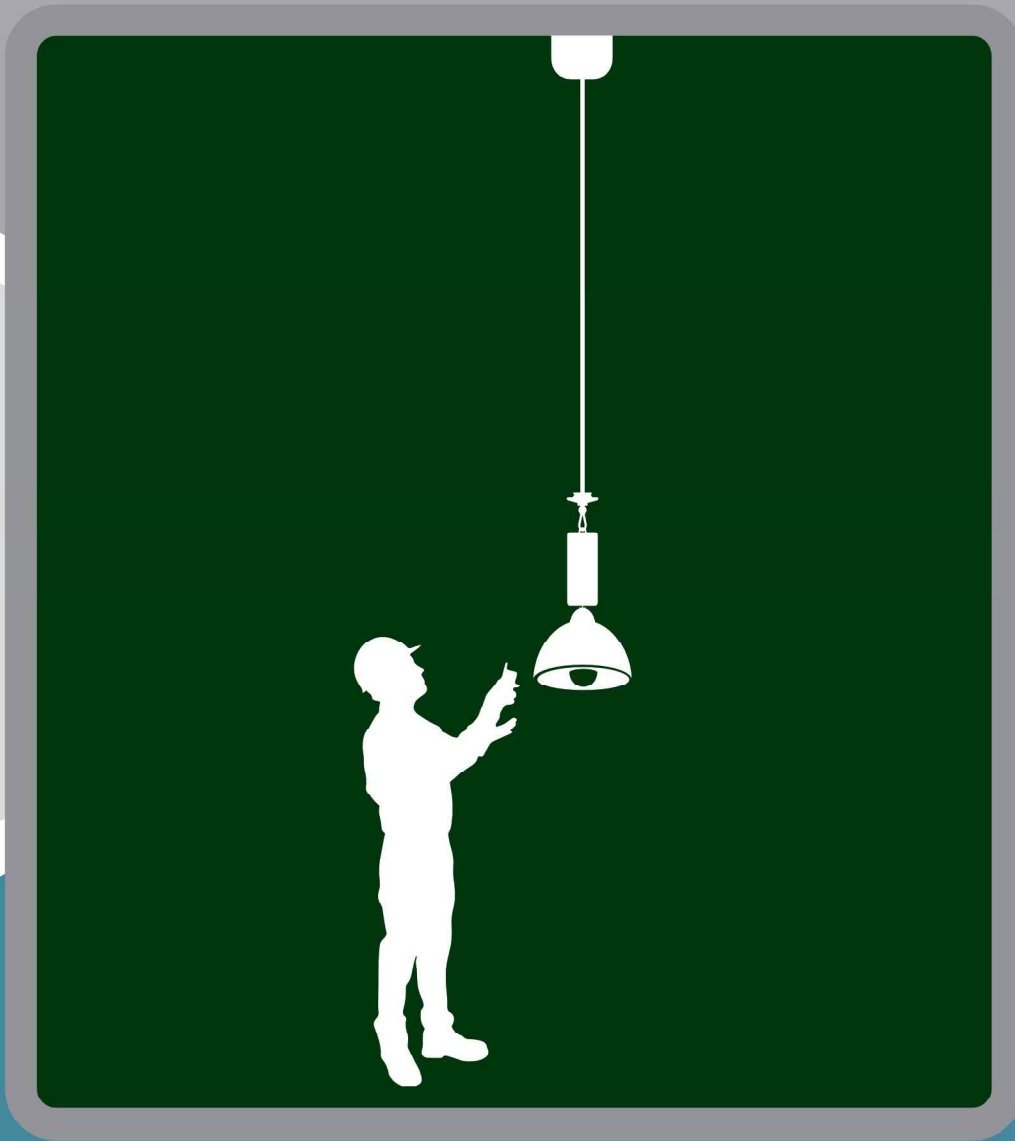

PRODUCT GUIDE 2023

Safety lifting system is required for LEDs, electrical outlets, CCTVs, fire detectors, ventilators, and banners.

Gymnasium, subway station, factory, distribution center, science room, practice room, swimming pool, church, cathedral

Wedding halls, banquet halls, hotels, airports, power plants, exhibition halls, etc.

Safety Lifting System

Lighting Lifter

									
MSI-3	MDI-5	CSI-12	CDI-15	HSI-18	HDI-25	PSI-20	PSI-30	PDI-35	PDI-50

Electrical outlet lifter

									
PFI-100	PFI-200	PFI-300	PFI-500	Highbay	LSI-10C	LSI-10L	LSI-PS	LSI-3	LDI-3

Multi Contacts Lifter

									
MSI-1M	MDI-5M	CSI-7M	CDI-15M	HSI-12M	HDI-25M	PSI-20M	PDI-35M	PSI-30M	PDI-50M

CCTV Lifter

					
MSI-1CH	MDI-5CH	CSI-7CH	CDI-12CH	HSI-12CH	HDI-25CH

Batten Lifter

		
Applied to all models	Fan Lifter	Multi Batten

Banner & Partion & Covid-19 lifter

		
BDL-2	BDL-2D	BDL-4D

Smoke Detector Lifter

		
FSI-1	Downlight lifter	Grill Lifter

RCU & SENSOR & WCP

				
RT-RCU	RT-IR	RT-WS	RT-WLS	R-WP

LED & Solar tracker with street lights

LED



Outdoor LED Lifter



Solar tracker with streets lights

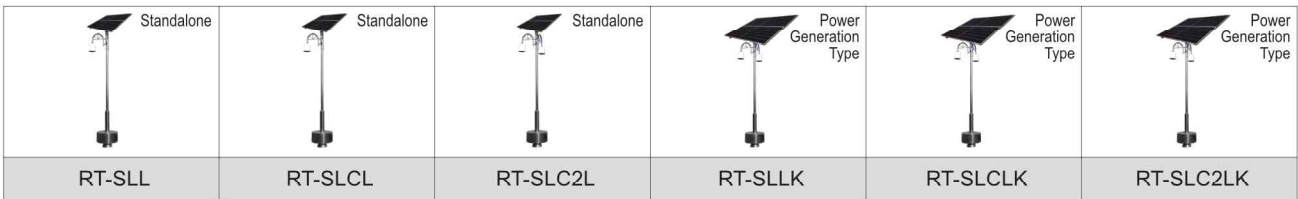

Product Certificate & Patent

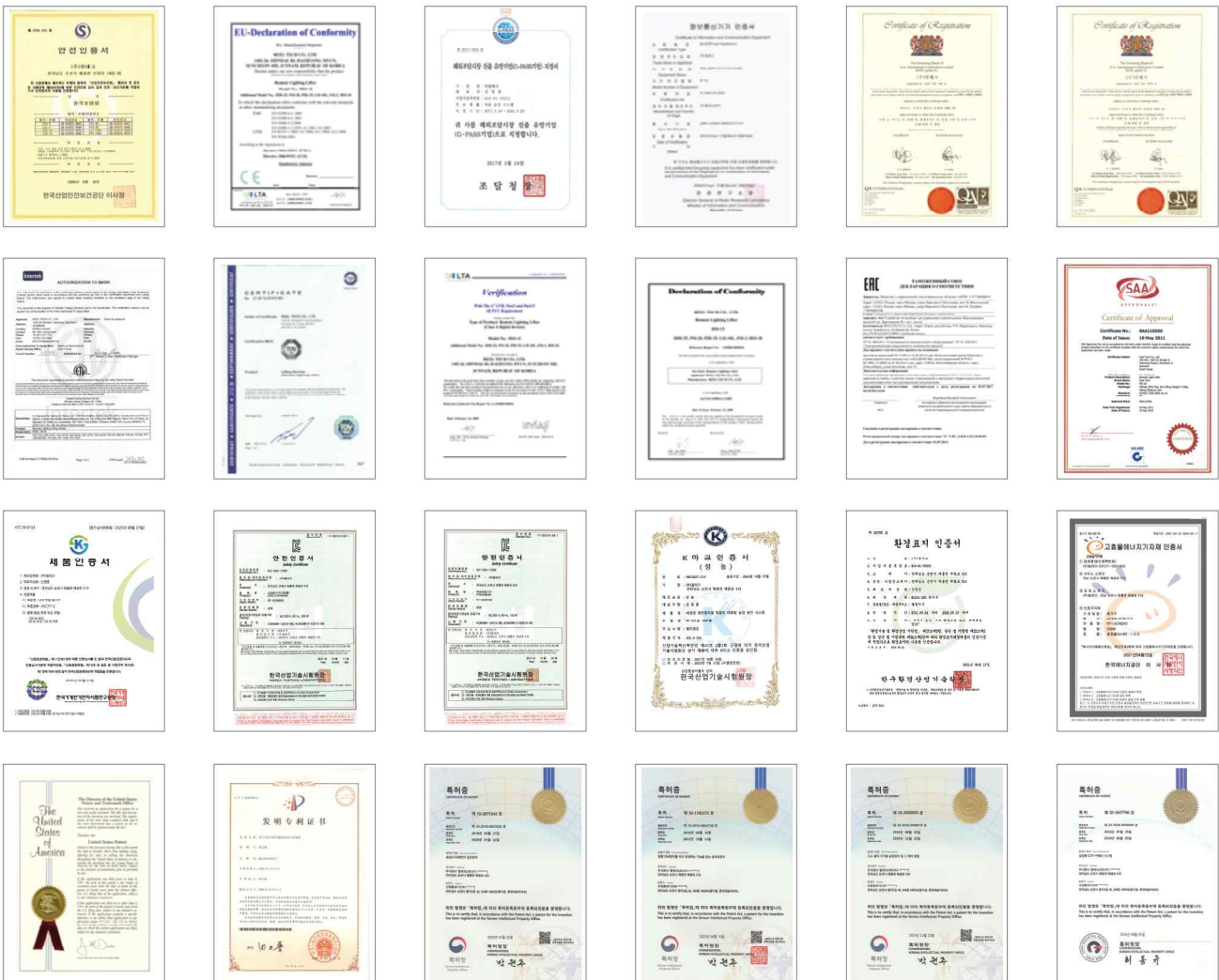



Move It! It's Possible!

Remote Lighting Lifter

Lighting maintenance can be safely on the ground



No danger!

No risk of work in high places and prevent the accident could happen during maintenance.



No equipment!

No need of rent the lifting equipment to maintenance.



No electric shock!

No electric current during maintenance and no risk of electric shock.



Safe!

Prevention of falling accident.
High place work
-> Ground work



Save cost!

No need a shutdown of operation.
Equipment rental fee saving.
Energy saving.



Fast!

Shortened maintenance time.
Immediately checking in case of necessity.



Remote Lighting Lifter

* Lowering height is an additional option.

Product						
Moder No.	MSI-3	MDI-5	CSI-12	CDI-15	HSI-18	HDI-25
Dimension(mm)	162.2(W)*170(H)		140(W)*140(D)*216(H)		175(W)*175(D)*228(H)	
Weight(kg)	2.2kg	2.2kg	3.1kg	3.13kg	6.6kg	6.69kg
Loading Weight(kg)	1~3kg	2~5kg	3~10kg	3~15kg	3~15kg	6~25kg
Loweing Height(M)	15M	7M	15M	7M	15M	7M
Number of Wire	1	2	1	2	1	2
Wire O.D	1.2mm	1.2mm	1.4mm	1.2mm	2.0mm	1.6mm
Circuits capacity	16A	16A	16A	16A	16A	16A
MOTOR	DC Motor	DC Motor	DC Motor	DC Motor	DC Motor	DC Motor

Product								
Moder No.	PSI-20	PDI-35	PSI-30	PDI-50	PFI-100	PFI-200	PFI-300	PFI-500
Dimension(mm)	209(W)*209(D)*276(H)		209(W)*209(D)*276(H)		410(W)*410(D)*635(H)			
Weight(kg)	7.63kg	7.63kg	8.44kg	8.44kg	57.5kg	58kg	58kg	59kg
Loading Weight(kg)	4~20kg	8~35kg	4~30kg	8~50kg	50~100kg	60~200kg	100~300kg	100~500kg
Loweing Height(M)	15M	7M	15M	7M	30M	20M	20M	15M
Number of Wire	1	2	1	2	4	4	4	4
Wire O.D	2.4mm	2.0mm	2.4mm	2.0mm	3.0mm	4.0mm	4.0mm	5.0mm
Circuits capacity	16A	16A	16A	16A	32A	32A	32A	32A
MOTOR	DC Motor	DC Motor	BLDC Motor	BLDC Motor	BLDC Motor	BLDC Motor	BLDC Motor	BLDC Motor

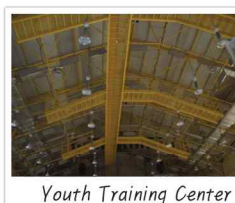
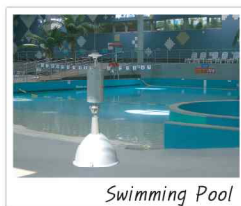



Move It! It's Possible! Electrical Outlet Lifter

• A long line of wires! Now, it is installed in the ceiling, and it is lowered when necessary!



✓ At school

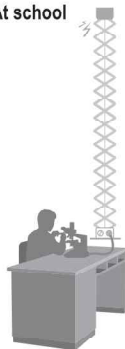

✓ At the factory



✓ At home

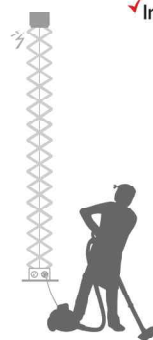

✓ In the office

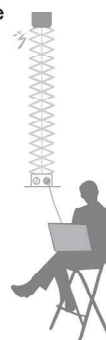

Office



Food Sales Place



School Science Room



Cooking Lab



Outdoor with Ceiling



Science Room



Science Room



Lab

● Electrical Outlet Lifter

* Lowering height is an additional option.

Product					
Model No.	LSI-10C	LSI-10L	LSI-PS	LSI-3	LDI-3
Dimension(mm)	300(W)*235(D)*570(H)	140(W)*140(D)*529(H)	440(W)*220(D)*296(H)	228(W) x 228(D) x 301(H)	
Weight(kg)	8.5kg	6.7kg	4.7kg	6.1kg	6.83kg
Loading Weight(kg)	-	3~7kg	10kg~	-	-
Loweing Height(M)	2M	2M~	2M~	2M/Max7M(option)	2M/Max3M(option)
Number of Wire	1	1	1	1	2
Wire O.D	1.4mm	1.4mm	1.4mm	-	-
Circuits capacity	16A	16A	16A	16A	16A
MOTOR	DC Motor	DC Motor	-	DC Motor	DC Motor

Utilization of cable type electrical outlet lifter

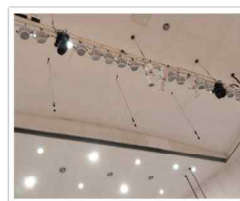
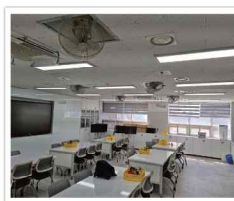
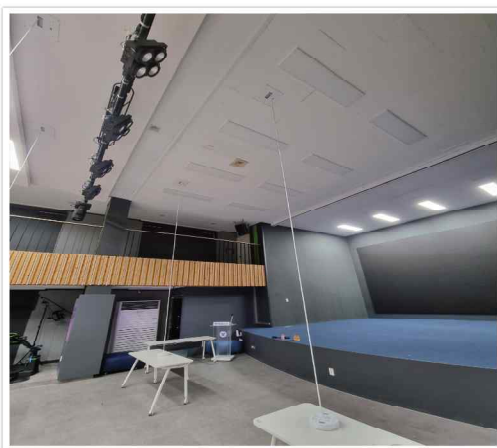
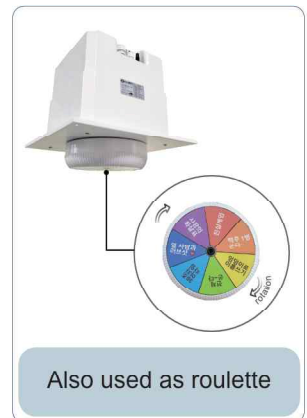



Move It! It's Possible!

Multi Contacts Lifter

Used in products such as square lighting, CCTV, speakers, and DALI that require directional functions

8 contacts(Single wire)



- ① — SIGNAL1
- ② — SIGNAL2
- ③ — SIGNAL3
- ④ — SIGNAL4
- ⑤ — EARTH(GREEN/YELLOW)
- ⑥ — POWER(L-BROWN COLOR)
- ⑦ — POWER(N-BLUE COLOR)
- ⑧ — SPARE

6 contacts(Double wire)





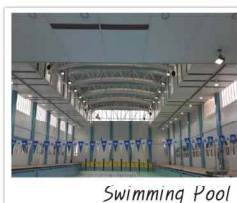

- ① — POWER(N-BLUE COLOR)
- ② — POWER(L-BROWN COLOR)
- ③ — SIGNAL1
- ④ — SIGNAL2
- ⑤ — SIGNAL3
- ⑥ — SIGNAL4



● Multi Contacts Lifter

* Lowering height is an additional option.

Product				
Model No.	MSI-1M	MDI-5M	CSI-12M	CDI-15M
Dimension(mm)	162(W) x 176.5(H)	162(W) x 176.5(H)	140(W) x 140(D) x 221(H)	140(W) x 140(D) x 221(H)
Weight(kg)	2.2kg	2.2kg	3.1kg	3.13kg
Loading Weight(kg)	1kg	2~5kg	3~7kg	3~15kg
Loweing Height(M)	15M	7M	15M	7M
Number of Wire	1	2	1	2
Wire O.D	1.2mm	1.2mm	1.4mm	1.2mm
Circuits capacity	16A	16A	16A	16A
MOTOR	DC Motor	DC Motor	DC Motor	DC Motor

Product						
Model No.	HSI-18M	HDI-25M	PSI-20M	PSI-30M	PDI-35M	PDI-50M
Dimension(mm)	175(W) x 175(D) x 251(H)	175(W) x 175(D) x 251(H)	209(W) x 209(D) x 298(H)		209(W) x 209(D) x 298(H)	
Weight(kg)	6.6kg	6.69kg	7.63kg	8.44kg	7.63kg	8.44kg
Loading Weight(kg)	3~12kg	6~25kg	4~20kg	4~30kg	8~35kg	8~50kg
Loweing Height(M)	15M	7M	15M	15M	7M	7M
Number of Wire	1	2	1	1	2	2
Wire O.D	2.0mm	1.6mm	2.4mm	2.4mm	2.0mm	2.0mm
Circuits capacity	16A	16A	16A	16A	16A	16A
MOTOR	DC Motor	DC Motor	DC Motor	BLDC Motor	DC Motor	BLDC Motor

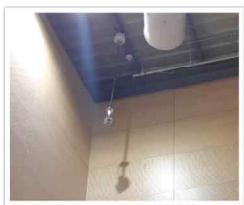
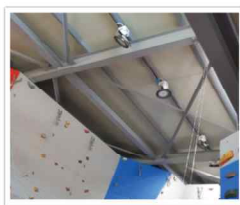
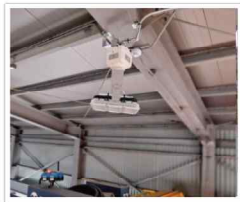



Move It! It's Possible!

Smoke Detector Lifter

Smoke Detector Lifter

*Lowering height is an additional option.

Product		
Moder No.	FSI-1	MSI-1M
Dimension(mm)	162(W) x 110(H)	162(W) x 176.5(H)
Weight(kg)	2.2kg	2.2kg
Loading Weight(kg)	1kg	1kg
Lowering Height(M)	15M	15M
Number of Wire	1	1
Wire O.D	1.2mm	1.2mm
MOTOR	DC Motor	DC Motor









Move It! It's Possible!

Batten Lifter

● Large promotion(decoration) materials, stage lighting, air circulation fans, lifting applications

Batten Lifter 2 lifters go up and down at the same time

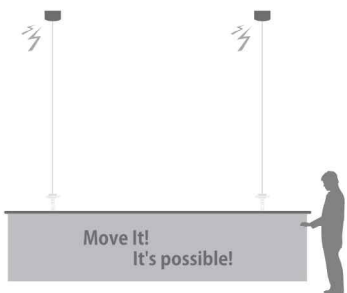

COMPACT



HOOK



HEAVY DUTY



SUPER HEAVY DUTY

▲ Applicable model

Multi Batten Lifters 3 or more lifters go up and down at the same time

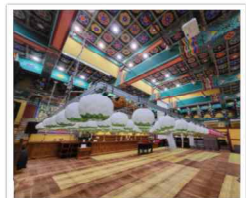
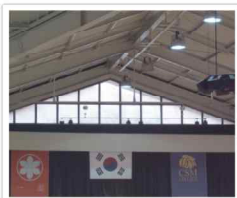
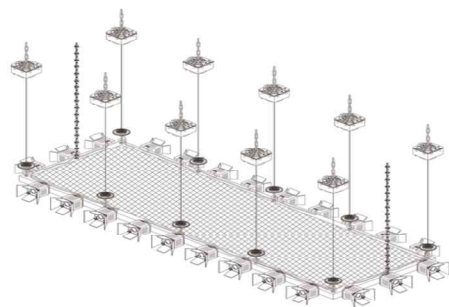



Move It! It's Possible!

CCTV Lifter

Why is the CCTV Lifter needed?

CCTV lens cleaning

Clear Video at all times

Have a clear sight at all times, because clean the lense of CCTV by the CCTV lifter.



Before cleaning the lens



After cleaning the lens

Safe to maintenance of CCTV

Industrial Accident Prevention

Industrial accidents such as fallen accident can be prevented because CCTVs are safely cleaned or maintained on the ground without the need to climb to a high place.



Working at high place : danger









Ground work : Safety



● CCTV Lifter

* Lowering height is an additional option.

Product				
Model No.	MSI-1CH	MDI-5CH	CSI-7CH	CDI-12CH
Dimension(mm)	185.4(W) x 208.8(H)	185.4(W) x 208.8(H)	248(W) x 292(H)	248(W) x 292(H)
Weight(kg)	3.7kg	3.7kg	6.2kg	6.2kg
Loading Weight(kg)	1kg	2~5kg	3~7kg	3~12kg
Lowering Height(M)	15M	7M	15M	7M
Number of Wire	1	2	1	2
Wire O.D	1.2mm	1.2mm	1.4mm	1.2mm
Circuits capacity	8	6	8	6
MOTOR	DC Motor	DC Motor	DC Motor	DC Motor

Product		
Model No.	HSI-12CH	HDI-25CH
Dimension(mm)	248(W) x 292(H)	248(W) x 292(H)
Weight(kg)	10kg	10kg
Loading Weight(kg)	3~12kg	6~25kg
Lowering Height(M)	15M	7M
Number of Wire	1	2
Wire O.D	2.0mm	1.6mm
Circuits capacity	8	6
MOTOR	DC Motor	DC Motor







Move It! It's Possible!
Banner & Partion & Covid-19 lifter

Public Relations & Droplet Blocking & Privacy Protection Effect!

Restaurant, cafe, company office, meeting room, banquet hall, exhibition, conference room, etc

- Banner & Partion & Covid-19 lifter



Product			
Model No.	BDL-2	BDL-2D	BDL-4D
Dimension(mm)	352.3(W) x 77.7(D) x 56(H)	213.3(W) x 77.7(D) x 56(H) * 2EA	352.3(W) x 77.7(D) x 56(H) * 2EA
Weight(kg)	3.1kg	3.1kg	6.2kg
Loading Weight(kg)	~2kg	~2kg	~2kg
Loweing Height(M)	4M	4M	4M
Number of Wire	2	2	4
Wire O.D	0.8mm	0.8mm	0.8mm
Circuits capacity	0.04A	0.04A	0.04A
MOTOR	AC Motor	AC Motor	AC Motor



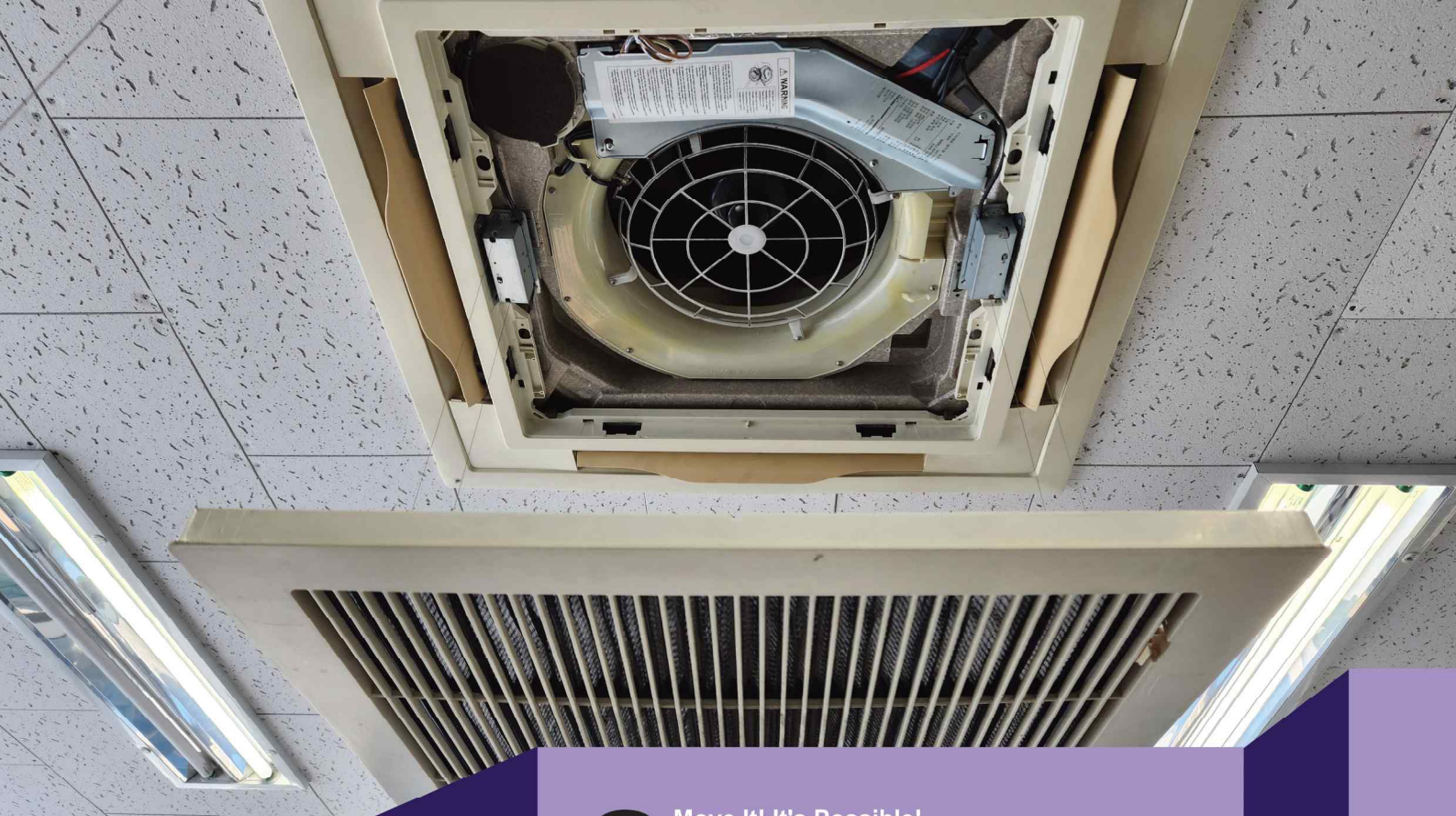

Move It! It's Possible!

Grill Lifter

● Grill Lifter for cleaning the grill of ceiling system air conditioners

If dust accumulates on the grill (filter) of the ceiling system air conditioner, the efficiency of the air conditioner decreases. Filters should be cleaned periodically as malfunctions may occur.

Product	
Model No.	GFL-3
Dimension(mm)	126(W) x 40(D) x 36(H)
Weight(kg)	0.5kg
Loading Weight(kg)	2kg
Lowering Height(M)	4M
Number of Wire	2
Wire O.D	0.8mm
Circuits capacity	0.6A
MOTOR	DC Motor

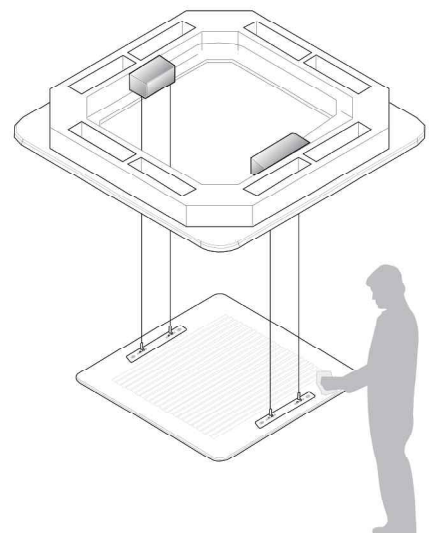



Move It! It's Possible!
LED & LED Lifter

● **Benefits**



Eco-friendly products



High efficiency certified product



KC certified product



KS certified product



Maintenance cost saving



Saving energy



Convenience

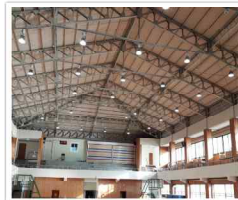

LED

* Lowering height is an additional option.

Product			
Model No.	RT-LEDN150	RT-LEDN200	CSI-LH200
Dimension(mm)	244(W) x 158(H)	244(W) x 158(H)	244(W) x 370(H)
Weight(kg)	3.1kg	3.1kg	9.3kg
Power consumption	150W	200W	200W
Power factor	0.95	0.96	0.96
Total flux	18778lm	24893lm	24893lm
Color temperature	5650K	5656K	5656K
Color rendering index	77	77	77
Input power	220V/60Hz	220V/60Hz	220V/60Hz

LED Lifter

▼ 40,000Hr/ 8year warranty (Only combined model)

Product						
Model No.	MSI-LN150	MSI-LN200	CSI-LN150	CSI-LN200	CSI-7D150	CSI-7D200
Dimension(mm)	244(W) x 285(H)	244(W) x 285(H)	244(W) x 329(H)	244(W) x 329(H)	244(W) x 344(H)	244(W) x 344(H)
Weight(kg)	5.3kg	5.3kg	6.2kg	6.2kg	6.2kg	6.2kg
Power consumption	1~3kg	1~3kg	2~7kg	2~7kg	2~7kg	2~7kg
Power factor	15M	15M	15M	15M	15M	15M
Total flux	1	1	1	1	1	1
Color temperature	1.2mm	1.2mm	1.4mm	1.4mm	1.4mm	1.4mm
Color rendering index	DC Motor	DC Motor	DC Motor	DC Motor	DC Motor	DC Motor
Input power	2	2	2	2	8	8

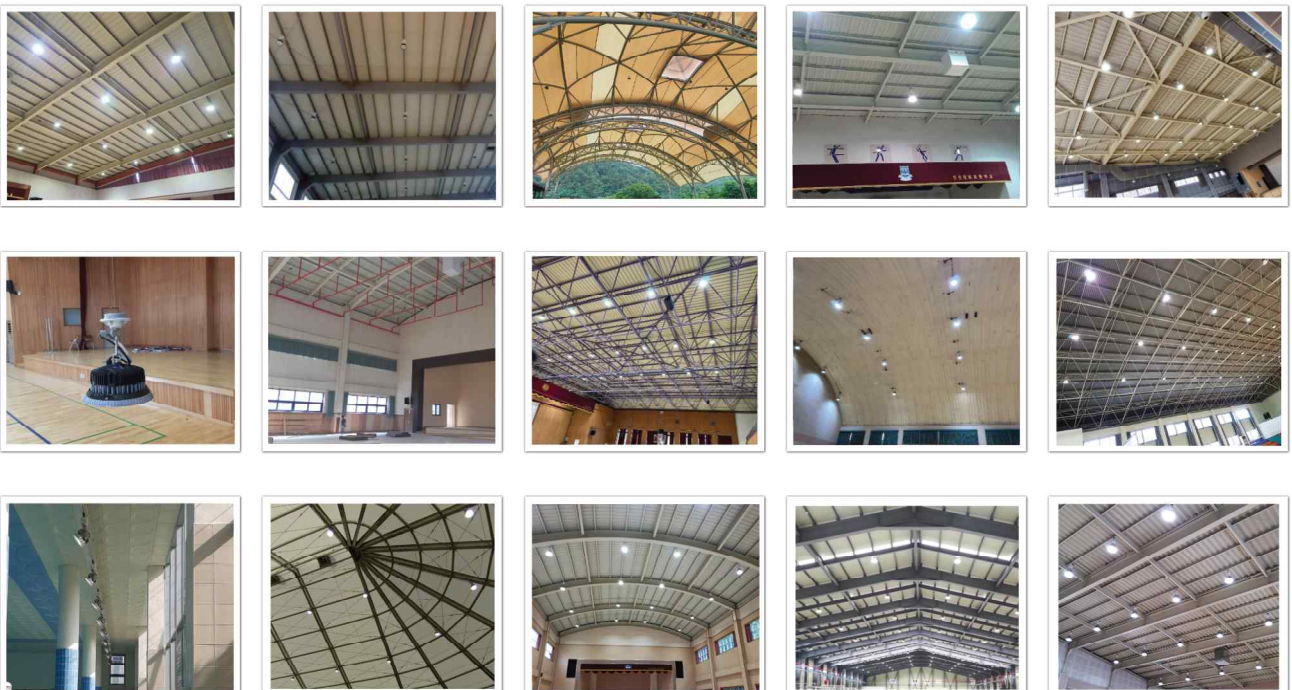



Move It! It's Possible!

Photovoltaic Elevating Security Pole

360 degree rotating photovoltaic elevating security pole

- ✓ Prevention of crime and provision of convenience facilities
- ✓ Independent system operated by self-generation without electricity and civil works
- ✓ Daily power consumption 300W = 1-hour power generation capability

Prevention of theft of agricultural products in the county

Prevent theft crimes in advance by installing them at entrances and exits to villages, farm roads, and back roads.



[National agricultural product theft damage case]

Prevention of crime in high-risk areas in the city

Prevent crime in advance by installing them in crime-susceptible areas (parks, Dulle-gil) in the city.



[The effect of installing CCTVs in Changgi]

Prevention of school violence

Prevent school violence in advance by installing them in crime-susceptible areas (around restrooms & dormitories) in schools.







[Places affected by school violence]







Certifications and patents



● Photovoltaic Elevating Security Pole

Components				
Product Name	Rotator	Photovoltaic panel	CCTV Lifter	LED
Specification	260 x 360 x 180mm(ID:140mm) 14.5kg	1306 x 660 x 40mm 240W or more	15m moving up and down CCTV (SD card type) Wireless monitoring function (WiFi)	50W Efficiency : 141.5lm/W Color rendering : 77.5
Features	<ul style="list-style-type: none"> - Contact method without wires (30-year contact lifespan is guaranteed.) - 360 degree rotation - GPS + Program control method 	<ul style="list-style-type: none"> - CE and RoHS-certified products - High-efficiency single crystal cell - High conversion efficiency 	<ul style="list-style-type: none"> - Completed wind tunnel test (at 30 m/s or more) - Periodic lens cleaning ensures clear images - Safe and convenient maintenance 	<ul style="list-style-type: none"> - Registration of conformity of broadcasting and communication equipment - Fulfilled minimum green standards for public procurement - Dimming function

Components				
Product Name	360 sensor	Battery storage box	Battery (solar power exclusive)	Pole
Specification	Sensing distance: 5~7 m	Φ670 x 276mm, Steel Plate	SB1000 12V-100AH 250 charge/ discharge cycles Maintenance-free sealed battery	3.5m, 6.0T pipe Φ139.8 x 4.85
Features	<ul style="list-style-type: none"> - LED control by detecting the motion 	<ul style="list-style-type: none"> - Used as a shelter chair - Anti-theft feature with the door not being exposed - Finished with Asa material with strong heat-resistant 	<ul style="list-style-type: none"> - Check the charging status easily (Magic eye indicator) - Preventing the inflow of external fire outbreak: Sealed cover - Use an isolation plate to prevent a short circuit 	<ul style="list-style-type: none"> - Hot dip coating

● Applicable place





● Installation cases



• Air circulation fan lifting device

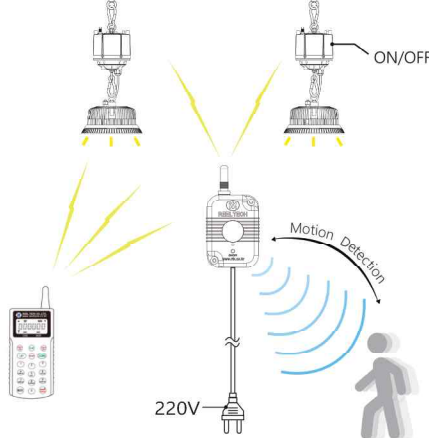
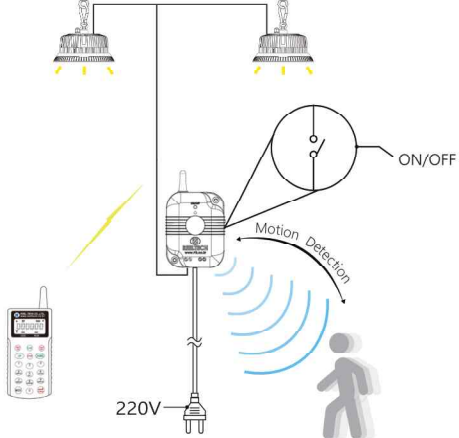

• Wireless Sensor & wireless switch

Product		
Model Name	RT-WS	RT-WLS
Dimension(mm)	57.3(W)x38.2(D)X78.2(H)	70(W)x41(D)X92(H)
Sensing Distance	5~7mm	5~7mm
Operating Temperature	-20°C~+60°C	-20°C~+60°C
Control quantity	Max. 1 million units	Max. 1 million units
Features	<ul style="list-style-type: none"> - Receives a remote control signal and turns on/off the lighting in the elevator - The human body detection function of the wireless sensor detects movement and turns on/off the lighting in the lifter - When motion is detected, the lights are ON, after a certain period of time (can be set from 1 to 99 minutes) the lights can be OFF 	<ul style="list-style-type: none"> - Receives a remote control signal or detects movement with the human body detection function to turn on/off the light from the wireless switch
How it works	 <p>Wireless Sensor(RT-WS)</p>	 <p>Wireless Switch(RT-WLS)</p>

Reference

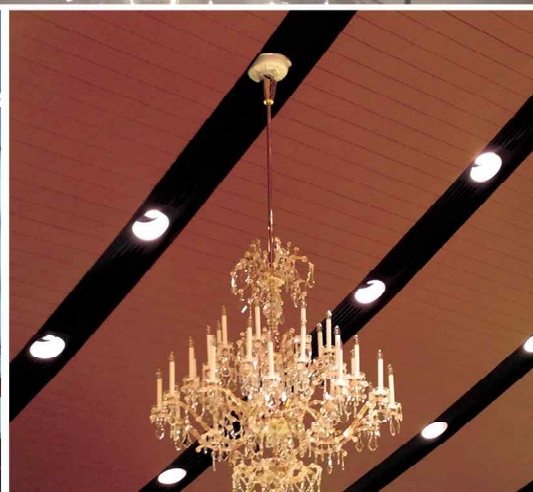
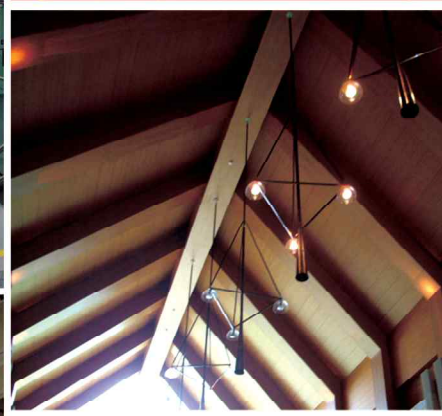
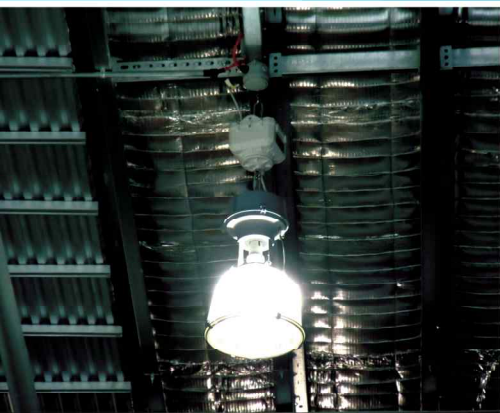

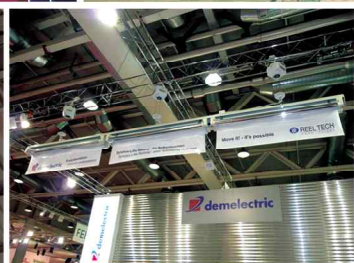
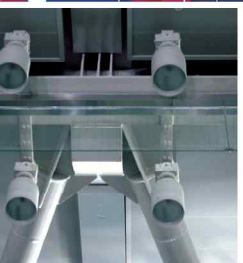
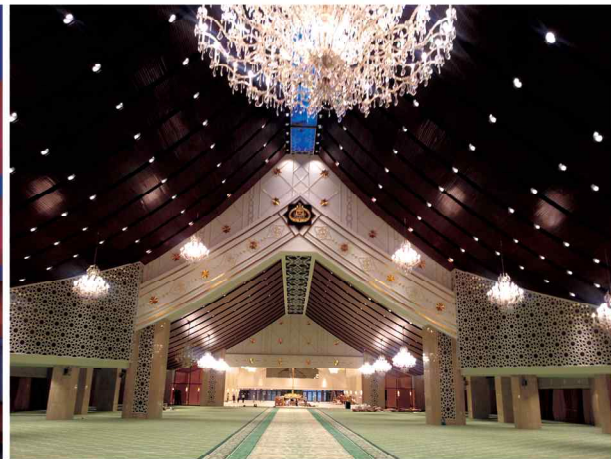
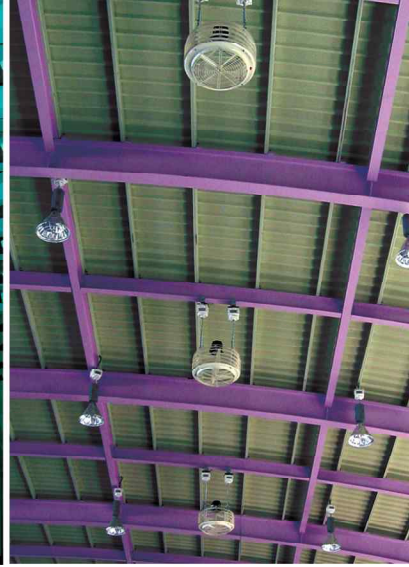
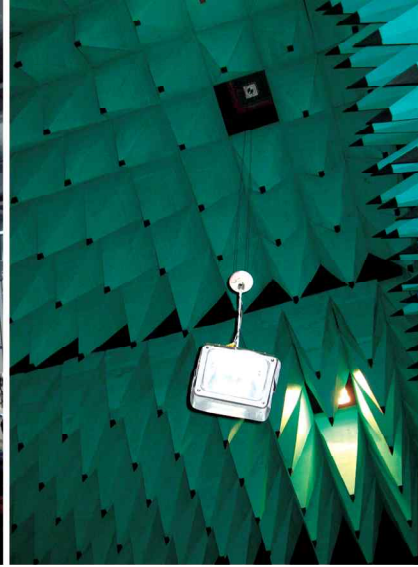

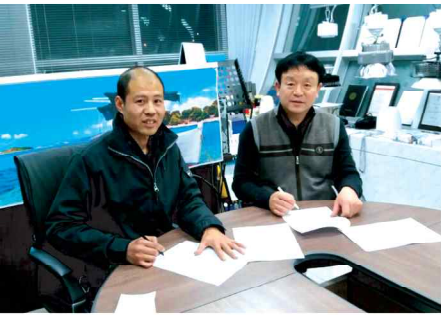
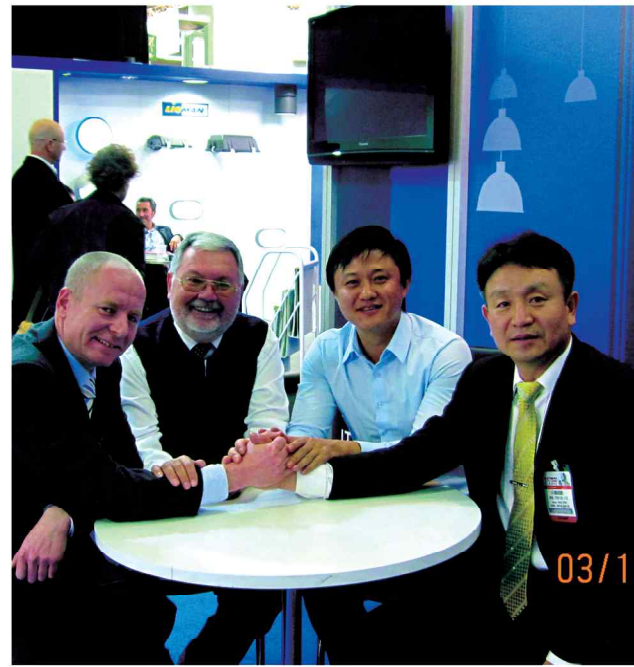
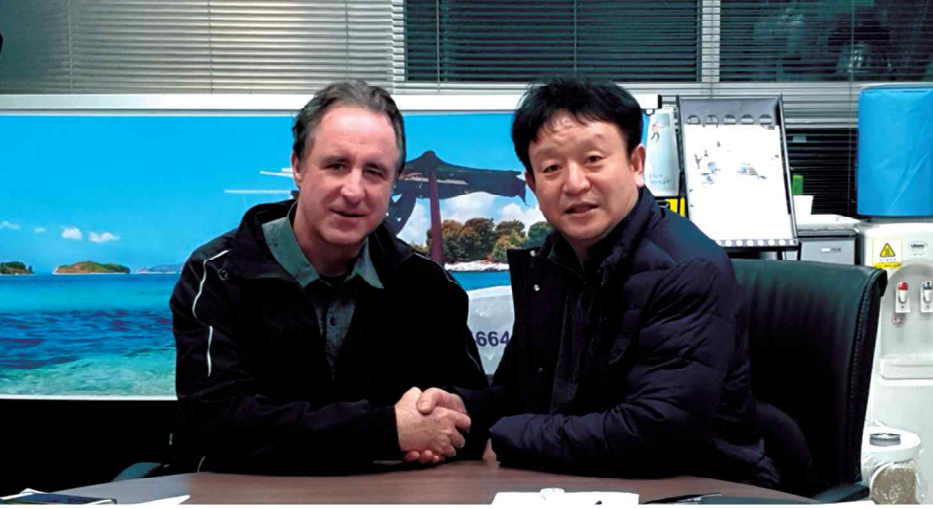



◆ Headquarter

REEL TECH CO., LTD. TEL : 061) 723-1113 FAX : 061) 723-4440 E-mail : reel-tech@hanmail.net <http://www.reeltech.co.kr>

◆ Domestic Agency

Area	Company Name	Tel.	Fax.	Homepage	E-mail
Seoul, Incheon	reeltech Seoul Incheon Branch	032-812-4023	032-812-4024	www.reeltech.co.kr	sbj00@hanmail.net
Kyeonggi-do	Seongwontop	010-9632-3578		www.reeltech.co.kr	swt9876@hanmail.net
Kangwon-do, Kyeongsang-do, Woolsan, Busan	Hanbit enerotech	052-991-7640~1	052-991-7642	www.reeltech.co.kr	hb7640@daum.net
Chungcheong-do, Sejong City, Daejeon	RGB tech	070-8880-9183	050-4060-9183	www.reeltech.co.kr	ljm99@daum.net
Jcollabuk-do	Esscolenc	063-224-4694	050-4461-4694	www.reeltech.co.kr	it0153@nate.com
Gwangju, Jeollanam-do	KStech	061-725-9964	061-724-9964	www.reeltech.co.kr	kstech3885@hanmail.net
Jeju-island	e2z	064-748-8446	064-748-8445	www.reeltech.co.kr	lenado@e2z.co.kr

◆ Oversease Dealer

Area	Company Name	Tel.	Fax.	Homepage	E-mail
Russia	PLATAN LLC	7(495)97-000-99		www.platan.ru	info@platan.ru
England	REELTECH UK LTD.	+44(0)1604 643522	+44(0)1604 697028	www.reeltechuk.com	enquiries@reeltechuk.com
Hungary	REEL TECH HandelsmbH	+43(0)1 960 80 88	+43(0)1 960 80 88 - 80	www.reeltech.eu	
Italy	Santerini S.r.l	+39 0331 924846	+39 0331 920606	www.santerini.it	daniele.serventi@santerini.it
Slovakia	AMI spol.s.r.o	+421 35 6923900	+421 35 6923960		ami@ami.sk
Czecho	BASE Diming s.r.o	+420 602 344 162			j.lamac@basediming.com
Austria	REEL TECH HandelsmbH	+43(0)1 960 80 88	+43(0)1 960 80 88 - 80	www.reeltech.eu	office@reeltech.eu
Germany	REEL TECH Vertriebs GmbH	+49(0) 6109 / 5016151	+49(0) 6109 / 5016150	www.reeltech.de	office@reeltech.de
Switzerland	Demelectric AG	+41(43) 455 4400	+41(43) 455 4411	www.demelectric.ch	info@demelectric.ch
Poland	MBB.s.c.	+48(0) 22 331 75 70	+48(0) 22 840 15 54	www.mbb.pl	mbb@mbb.pl
Singapore	LIGHTCRAFT PTE LTD	+65 6744 2441	+65 6744 1416	www.lightcraft.com.sg	enquiry@lightcraft.com.sg
Australia	LIGHT MOUNTING SYSTEMS	+61 02 4932 9000	+61 02 4932 9009	www.reeltechaustralia.com.au	sales@lmsau.com
Kuwait	YOUSEF AL-AHMAD INT GROUP	+965 24821302	+965 24847725	www.alahmedgroup.com	info@alahmedgroup.com
Bahrain	Genprise Co. W.L.L.	+973 17311442	+973 17311019/17910761	www.genpriseco.com	info@genpriseco.com
France	MINOEUROPE SARL	+33 6 22 70 43 45			Haemaru.ryu@minoeurope.com
Mexico	AG Lighting SA de CV	+(52) (55) 6045-6002		www.aglighting.mx	contacto@aglighting.mx
Colombia	ZONA DE ENFOQUE NETWORK S.A.S	+57 314 892 53 17		www.reeltechcolombia.co	gerencia@reeltechcolombia.co
Iran	BHE CO.	+98 713 648 0010	+98 713 648 0011	www.inenop.com	s.Afsar@bhe-co.com
China	SHENZHEN PHANS	+86 755 8621 8116		www.nuclearscm.com	1309582350@qq.com
China	TIANJIN CHUANGFA TECHNOLOGY	+86 22 2368 9010			13920555675@163.com
China	Txzz(WuHan) Technology	+86 138-7123-9075			2024225975@qq.com
Hong kong	Lightcraft Limited	+852 2866 6965		www.lightcraftintl.com	info@lightcraft.asia